

GUIDE TO PLASMA CUTTING



 **JASIC**

The power in inverter technology



 **WILKINSON STAR**
wilkinsonstar.com



This guide is designed to provide helpful information relating to the electric arc welding and cutting process.

The guide is split into specific areas of welding and cutting and designed to give an understanding of these areas.

The guide is not designed to be a comprehensive text book and the concept is to convey knowledge and techniques by theory and practical methods.

It should be understood that methods may not be the "only way to do it" but represent many current practices and systems.

The guides are constantly reviewed to incorporate any changes in procedures, technologies and equipment.

Wilkinson Star Limited own full copyright in respect of this manual and its reproduction.

No part of this manual may be reproduced by any means photocopy, electronic, mechanical or otherwise without the prior written permission of Wilkinson Star Limited.



E & O. E. Wilkinson Star Ltd 2017

What is Welding?	4
General Safety Instructions	8
What is the PLASMA Cutting Technology?	12
What is PLASMA	13
What makes up a Plasma Cutting System?	15
Pilot Arc Starting Methods	16
The Plasma Torch	17
Plasma Cutting Process Variations	18
Plasma System Gas Supplies	22
Compresses Air Supplies	24
Types of Plasma Cutting	25
Cut Quality	27
Plasma Cutting Problems	30

NOTES

A series of horizontal dashed lines for writing notes.



What is Welding?

Welding is the process of joining together two or more pieces using heat and/or pressure to form a high strength joint. There are many ways to perform a weld and these require different skill levels and can utilise many levels of technology in the equipment used.

To carry out a weld a heat source is required.

This can be thermo chemical energy which is produced using a combination of gases such as oxygen and acetylene to produce a flame. This process was widely used but requires a high level of manual skill and dexterity. Another source is electrical energy. This is where an arc is established between the electrical source or Arc welding power source and the work piece. This process is referred to as Arc welding or Arc cutting and can produce heat at temperatures from 3000°C to 20,000°C. Arc welding can be used on a wide range of different metals, alloys and materials. Dependent on the process and welding result required Arc welding requires different skill and dexterity levels. Arc welding uses a wide range of power source types from basic transformers to equipment which utilises high levels of technology.

The applications which utilise Arc welding are extensive, from DIY to nuclear, structural fabrication to aerospace, vehicle repair to vehicle assembly, robot automation to offshore the list is endless. Welding can be carried out pretty much anywhere...

The Arc welding and cutting processes covered:

- Manual metal arc
- MIG (Metal inert gas) process
- MAG (Metal active gas) process
- FCW (Flux cored welding) process
- TIG (Tungsten inert gas) process
- Plasma arc cutting process
- Resistance welding

The individual process information will be given in the related units. In addition to the above processes there are others such as laser, submerged arc, ultrasound and friction welding.

The materials welded?

The most commonly welded materials are aluminium, mild steel, stainless steel and their alloys. Also in today's rapidly changing world many plastics can also be welded.

Which process?

The welding process used is chosen based on the materials to be welded and the material thickness. Also to be taken into consideration is the production rate and visual aesthetics of the weld which may be on show.

Manual Arc (MMA)

This is one of the oldest processes and is still in common use. It is well suited to use welding outdoors and in repair work. It is a slow process however and requires a high skill level but can be used on a wide range of materials. It can also be used in confined areas as the electrodes can be bent into shape for access. Equipment costs are lower than the other processes.

Metal inert/active gas (MIG/MAG)

The process is a common, versatile welding process. It provides high deposition rates and is suited to a wide range of material thicknesses, thin to thick. Compared with Manual Arc welding the process provides a weld with minimal weld finishing as there is minimal spatter and no electrode slag. It requires a low - medium skill level and has less problems to achieve good quality compared to TIG/MMA it has a narrow heat affected area. Its disadvantage is the torch as it is subject to a number of wear components such as contact tips, nozzles, liners etc. It is often a process that is automated to provide even higher production rates.



Flux Cored Welding (FCW)

Flux cored welding is a type of MIG/MAG welding using a standard MIG/MAG power source but uses a consumable which may contain a core of constituents which allow the process to self-shield itself therefore requiring no additional gas shield supply. This makes it suitable for welding in areas where there may be draughts such as outdoors. In addition, consumables may contain elements to provide high deposition rates and hence productivity. The flux core however produces a slag coating which need to be cleaned after welding.

Tungsten Inert Gas (TIG)

TIG welding, is an arc welding process that uses a non-consumable tungsten electrode to produce the weld. The weld area and electrode is protected from oxidation or other atmospheric contamination by an inert shielding gas (argon or helium), and a filler metal is normally used, though some welds, known as autogenous welds, do not require it. A constant-current welding power supply produces the electrical energy, which is conducted across the arc through a column of highly ionized gas. TIG offers a high quality weld although generally a slower process compared to the others which requires a higher skill level.

Plasma Cutting

The basic principle is that the arc formed between the electrode and the work piece is constricted by a fine bore nozzle.

This constriction increases the temperature and velocity of the plasma emanating from the nozzle.

The temperature of the plasma arc is in excess of 20,000°C and the velocity can approach the speed of sound. When used for cutting, the plasma gas flow is high and creates a deeply penetrating high temperature plasma jet there by cutting through the material.

The force of the arc blows away any molten material in the form of dross.

The plasma process operates by using the high temperature arc to melt the metal. The plasma process can therefore be used to cut metals including cutting metals which form refractory oxides such as stainless steel, aluminium, cast iron and non-ferrous alloys. The cut quality is dependent on many parameters but the system is easy to use and often is the only practical or cost effective solution.



What is Welding?

Resistance Welding (Spot)

Resistance welding (Spot) is also one of the oldest of the electric welding processes in use in the welding industry today. The weld is made by a combination of heat, pressure and time. It is the resistance of the material to be welded to current flow that creates a localised heating in the material to be welded and hence the name resistance welding.

The resistance of different materials will create different levels of heat for the same current passing through it.

The pressure exerted by the electrode arms and electrode tips through which the current flows, holds the parts to be welded in intimate contact before, during, and after the welding current time cycle. The required amount of time current flows in the joint is determined by material thickness and type, the amount of current flowing and the cross-sectional area of the welding tip contact surfaces.



Industry examples that use welding and cutting processes.



Process Comparison

	TIG WELDING	MMA WELDING	MIG WELDING
Skill level required	High	High – Especially for high quality and non ferrous material	Low - Medium
Quality	Requires high skills for good quality	Requires high skills for good quality	Less problems to achieve good quality compared to TIG/MMA
Distortion/heat input	High	High	Low-narrow heat affected area
Ease of mechanisation	Some difficult positions	Difficult	Simple
Equipment maintenance	Needs training	Needs basic training	Needs training
Consumable parts	Negligible	Negligible	Torch components such as contact tips, nozzles, liners etc.

Equipment must only be used for the purpose it was designed for. Using it in any other way could result in damage or injury and in breach of the safety rules. Only suitably trained and competent persons should use the equipment. Operators should respect the safety of other persons.

PPE and workplace safety equipment must be compatible for the application of work involved

Use of personal protective equipment (PPE)

Welding arc rays from all the welding processes produce intense, visible and invisible (ultraviolet and infrared) rays that can burn eyes and skin.

- Wear an approved welding helmet fitted with an appropriate shade of filter lens to protect your face and eyes when welding or watching.
- Wear approved safety glasses with side shields under your helmet.
- Never use broken or faulty welding helmets.
- Always ensure there are adequate protective screens or barriers to protect others from flash, glare and sparks from the welding area.
- Ensure that there are adequate warnings that welding or cutting is taking place.
- Wear suitable protective flame resistant clothing, gloves and footwear.
- Check and be sure the area is safe and clear of inflammable material before carrying out any welding.



Some welding and cutting operations may produce noise. Wear safety ear protection to protect your hearing if the ambient noise level exceeds the allowable limit (e.g: 85 dB).

CURRENT	MMA ELECTRODES	MIG LIGHT ALLOYS	MIG HEAVY METALS	MAG	TIG ON ALL METALS	PLASMA CUTTING	PLASMA WELDING	GOUGING ARC/AIR
10	8							
15					9		10	
20								
30	9	10	10	10	10			
40							11	
60	10					11		10
80						11		
100				11			12	
125								
150	11	11	11	12	12			
175								
200							13	
225		12			13	12		11
250	12		12	13				12
275								
300		13						13
350								
400	13	14	13	14	14	13	14	
450								14
500	14	15	14	15				15

Safety against fumes and welding gases

Locate the equipment in a well-ventilated position. Keep your head out of the fumes. Do not breathe the fumes. Ensure the welding zone is in a well-ventilated area.

If this is not possible provision should be made for suitable fume extraction. If ventilation is poor, wear an approved respirator.

Read and understand the Material Safety Data Sheets (MSDS's) and the manufacturer's instructions

for metals, consumable, coatings, cleaners and de-greasers. Do not weld in locations near any de-greasing, cleaning or spraying operations. Be aware that heat and rays of the arc can react with vapours to form highly toxic and irritating gases.



An example of personal fume extraction

Precautions against fire and explosion

Avoid causing fires due to sparks and hot waste or molten metal.

Ensure that appropriate fire safety devices are available near the cutting/welding area.

Remove all flammable and combustible materials from the cutting/welding zone and surrounding areas. Do not cut/weld fuel and lubricant containers, even if empty. These must be carefully cleaned before they can be cut/welded.

Always allow the cut/welded material to cool before touching it or placing it in contact with combustible or flammable material.

Do not work in atmospheres with high concentrations of combustible fumes, flammable gases and dust.

Always check the work area half an hour after cutting to make sure that no fires have begun.

Take care to avoid accidental contact of electrode to metal objects.

This could cause arcs, explosion, overheating or fire.

Understand your fire extinguishers

General operating safety

Never carry the equipment or suspend it by the carrying strap or handles during welding.

Never pull or lift the machine by the welding torch or other cables. Always use the correct lift points or handles. Always use the transport under gear as recommended by the manufacturer.

Never lift a machine with the gas cylinder mounted on it.

If the operating environment is classified as dangerous, only use S-marked welding equipment with a safe idle voltage level. Such environments may be for example: humid, hot or restricted accessibility spaces.



Working environment

Ensure the machine is mounted in a safe and stable position allowing for cooling air circulation.

Do not operate equipment in an environment outside the laid down operating parameters.

The welding power source is not suitable for use in rain or snow.

Always store the machine in a clean, dry space.

Ensure the equipment is kept clean from dust build up.

Always use the machine in an upright position.

Protection from moving parts

When the machine is in operation keep away from moving parts such as motors and fans.

Moving parts, such as the fan, may cut fingers and hands and snag garments.

Protections and coverings may be removed for maintenance and controls only by qualified personnel after first disconnecting the power supply cable.

Replace the coverings and protections and close all doors when the intervention is finished and before starting the equipment.

Take care to avoid getting fingers trapped when loading and feeding wire during set up and operation.

When feeding wire be careful to avoid pointing it at other people or towards your body.

Always ensure machine covers and protective devices are in operation.

Risks due to magnetic fields

The magnetic fields created by high currents may affect the operation of pacemakers or electronically controlled medical equipment.

Wearers of vital electronic equipment should consult their physician before beginning any arc welding, cutting, gouging or spot welding operations.

Do not go near welding equipment with any sensitive electronic equipment as the magnetic fields may cause damage.

Keep the torch cable and work return cable as close to each other as possible throughout their length.

This can help minimise your exposure to harmful magnetic fields.

Do not wrap the cables around the body.

Handling of compressed gas cylinders and regulators

Always check the gas cylinder is the correct type for the welding to be carried out.

All cylinders and pressure regulators used in welding operations should be handled with care.

Never allow the electrode, electrode holder or any other electrically "hot" parts to touch a cylinder.

Keep your head and face away from the cylinder valve outlet when opening the cylinder valve.

Always secure the cylinder safely and never move with regulator and hoses connected.

Always check for leaks.

Never deface or alter any cylinder

General electrical safety

The equipment should be installed by a qualified person and in accordance with current standards in operation. It is the users responsibility to ensure that the equipment is connected to a suitable power supply. Consult with your utility supplier if required. Do not use the equipment with the covers removed.

Do not touch live electrical parts or parts which are electrically charged.

Turn off all equipment when not in use.

In the case of abnormal behaviour of the equipment, the equipment should be checked by a suitably qualified service engineer.

If earth bonding of the work piece is required, bond it directly with a separate cable with a current carrying capacity capable of carrying the maximum capacity of the machine current.

Cables (both primary supply and welding) should be regularly checked for damage and overheating.

Never use worn, damaged, under sized or poorly jointed cables.

Insulate yourself from work and earth using dry insulating mats or covers big enough to prevent any physical contact.

Never touch the electrode if you are in contact with the work piece return.

Do not wrap cables over your body.

Ensure that you take additional safety precautions when you are welding in electrically hazardous conditions such as damp environments, wearing wet clothing and metal structures.

Try to avoid welding in cramped or restricted positions.

Ensure that the equipment is well maintained. Repair or replace damaged or defective parts immediately.

Carry out any regular maintenance in accordance with the manufacturers instructions.

The EMC classification of this product is class A in accordance with electromagnetic compatibility standards CISPR 11 and IEC 60974-10 and therefore the product is designed to be used in industrial environment only.

WARNING: This class A equipment is not intended for use in residential locations where the electrical power is provided by a public low-voltage supply system. In those locations it may be difficult to ensure the electromagnetic compatibility due to conducted and radiated disturbances.

Materials and their disposal

Welding equipment is manufactured with BSI published standards meeting CE requirements materials which do not contain any toxic or poisonous materials dangerous to the operator.

Do not dispose of the equipment with normal waste. The European Directive 2012/19/EU on Waste Electrical and Electronic Equipment states the electrical equipment that has reached its end of life must be collected separately and returned to an environmentally compatible recycling facility for disposal.

For more detailed information please refer to the HSE website www.hse.gov.uk



What is Plasma Cutting Technology?

During the 2nd World War, American factories were producing military vehicles and aircraft almost five times faster than other countries. This was largely due to the great number of innovations by private industry in the field of mass production.

One area of importance was the requirement to cut and join aircraft parts more efficiently. Many factories working on military aircraft adopted a new method of welding that involved the use of an inert gas fed through an electric arc. The engineers discovered that by charging the gas with an electric current this formed a barrier around the weld, which protected it from oxidation whilst being electrically conductive. This new method, TIG or GTAW welding made for much cleaner welds and much sturdier construction.

In the early 1960's, engineers made a discovery, this was that they could boost the TIG welding arc temperatures by speeding up the flow of gas and directing the arc through a constricting nozzle. This method could reach higher temperatures than any other commercial welder. The high speed ionized gas or plasma, conducts electricity from the torch of the power source to the work piece. The plasma heats the work piece melting the material. The high velocity stream of ionized gas mechanically blows the molten metal away, severing tough metals like a hot knife through butter. This introduction of what is referred to as the plasma arc revolutionized the speed, accuracy and types of cuts manufacturers could make in all types of conductive metals.

States of Matter

A plasma cutting arc can pass through metals with little or no resistance thanks to the unique properties of plasma. There are four states of matter. Most things we deal with in our daily lives are in the form of solids, liquids or gases. The four states are divided based on the way that molecules behave within each one.

Take water as an example:

The solid state of water is ice. Ice is made up of neutrally charged atoms arranged in a hexagonal pattern that forms a solid. Because the molecules stay fairly still relative to each other, they form a solid-something that holds its shape.

Water in its liquid form is its common state. The molecules are still bound to each other but they move relative to each other at slow speeds. The liquid has a fixed volume but no constant shape.

It changes shape to fit whatever container you put it in.

The gas state of water takes the form of steam. In steam, molecules move around at high speeds independently of each other. Because the molecules are not bound to each other, the gas has no fixed shape or fixed volume.

If we take the water in solid state ice and apply heat the amount of heat (which translates to the amount of energy) applied to water molecules determines their behaviour and therefore their state. Basically, more heat (more energy) excites molecules to the point that they break free of bonds that bind them together.

With minimal heat (state 1), the molecules are tightly bound and you get a solid. With more heat, the molecules escape the rigid bonds and you get a liquid (state 2). With even more heat, the molecules escape the loose bonds and you get a gas, steam (state 3).

So what would happen if you were to heat gas even more?

This brings us to the fourth state: Plasma.

What is Plasma?

If you increase gas to an extremely high temperature you get the fourth state plasma.

The energy begins to break apart the gas molecules and the atoms begin to split. Normal atoms are made up of protons and neutrons in the nucleus surrounded by a cloud of electrons. In plasma, the electrons separate from the nucleus.

Once the energy of heat releases the electrons from the atom, the electrons begin to move around quickly.

The electrons are negatively charged and they leave behind their positively charged nuclei. These positively charged nuclei are known as ions. When the fast-moving electrons collide with other electrons and ions, they release vast amounts of energy. This energy is what gives plasma its unique status and unbelievable cutting power.

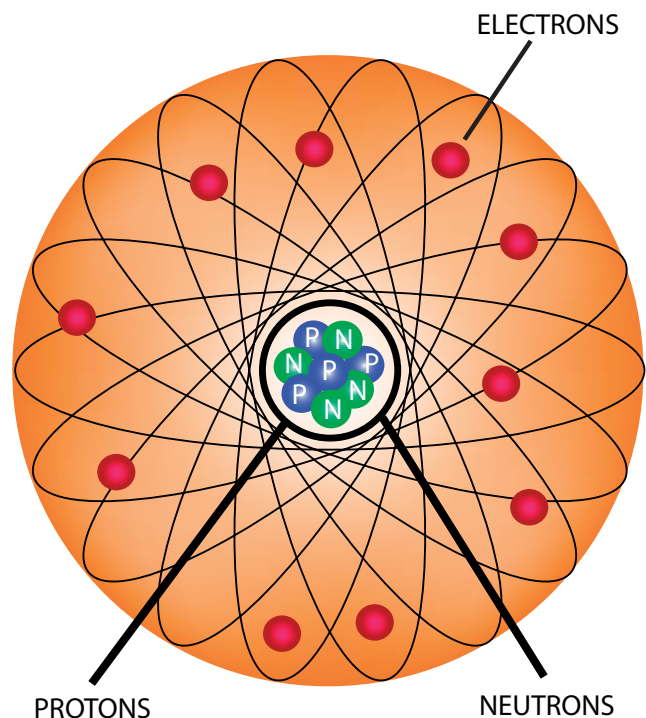

An example of naturally occurring plasma is lightning.

Plasma cutters are not the only devices to harness the power of plasma.

Neon signs, fluorescent lighting and plasma TV displays are just a few examples which utilise the property. These devices use 'cool' plasma. Though cool plasma cannot be used to cut metals, it has many useful applications.



Process Basics

The plasma arc cutting process basics can be seen in the illustration.

The basic principle is that the arc is formed between the electrode and the work piece through a constricting fine bore copper nozzle. This will increase the speed and temperature of the plasma exiting the tip. The temperature of the plasma is in excess of 15000°C and the speed can approach that of sound. This plasma gas flow in conjunction with the high temperature enables a deeply penetrating plasma jet to cut through the work piece material and at the same time molten material is blown away from the cut.

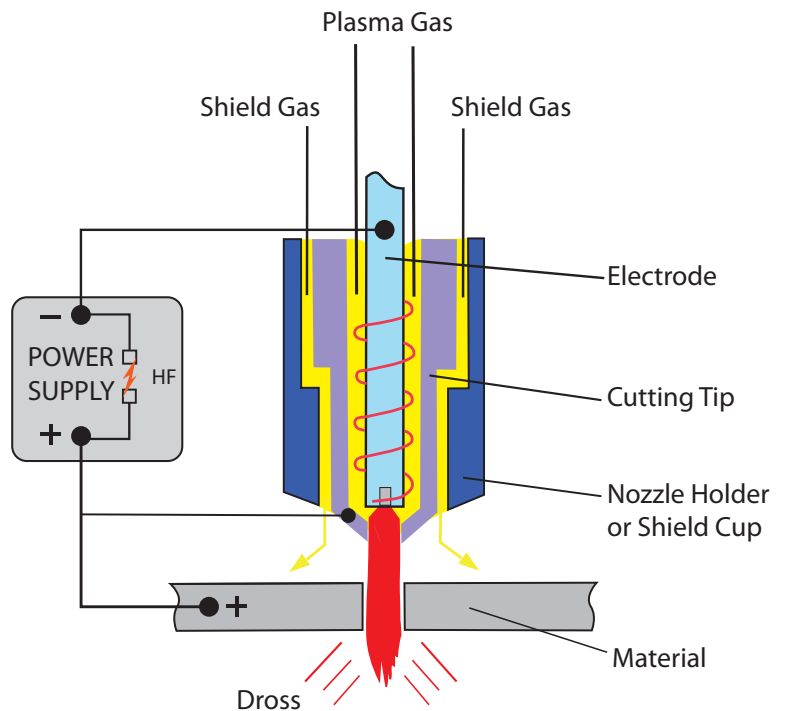

The process differs from the oxy-fuel process in that the plasma process works by using the high temperature arc to melt the metal to be cut. With the oxy-fuel process, the oxygen oxidises the metal to be cut and the heat from the exothermic reaction melts the metal. So, unlike the oxy-fuel process, the plasma process can be used to cut metals including those which form protective refractory oxides such as aluminium, stainless steel, non-ferrous alloys and cast iron.

What makes up a Plasma Cutting System?

The Plasma cutting process is an effective means of cutting both thin and thick materials. Hand-held torches can usually cut up to around 50mm thick steel plate, whilst larger automated water cooled machine mounted torches can cut steel up to 150mm often used with a mechanised computer controlled system.

Formerly, plasma cutters could only work on conductive materials; however, new technologies allow the plasma ignition arc to be enclosed within the nozzle, thus allowing the cutter to be used for non-conductive work pieces such as glass and plastics (special conditions apply).

For the purposes of this guide we will only deal with the plasma cutting of metals.

The Plasma Cutting Power Source

The power source required for the plasma arc process is a DC output and must have a drooping characteristic and a high voltage.

The operating voltage needed to maintain the plasma arc is typically 90 to 130 VDC, but the open circuit voltage needed to initiate the arc can be as high as 330V DC.

Machines come in a wide variety of formats from transformer rectifier to inverter type.

Inverters are particularly suited to applications which require precise control or portability.

When the process is started, what is called a pilot arc is formed within the torch body between the electrode and the cutting tip. To start cutting, the arc must be transferred to the work piece from the nozzle in what is referred to as 'transferred' arc mode. The electrode has a negative polarity and the work piece a positive polarity so that the majority of the arc energy (approximately two thirds) is used for cutting.



Pilot Arc Starting Methods

Plasma cutters use a number of methods to start the pilot arc. These will often depend upon the age of the machine and the environment it is being used in.

Older plasma cutters have a pilot arc that utilizes high frequency, high voltages and a spark gap to conduct electricity through the air. However, in this high tech modern age high frequency can interfere with sensitive equipment, computers or office equipment that may be in use in the local area. This method has other areas of concern such as risk of electrocution, machine maintenance, difficulty of repair and sparkgap maintenance, in addition to its RF (radio frequency) emissions.

Due to these problems, alternate methods of starting were developed that eliminate the potential problems associated with high frequency starting circuits where plasma cutters work near sensitive electronics, such as CNC hardware or computers.

One starting method is via a capacitive discharge into the primary circuit through an SCR (silicon controlled rectifier). This releases a short high energy burst to create a spark to transfer the arc. The 'blow apart' arc method features the tip and electrode initially in contact within the torch head. When the torch trigger is operated, a current flows between the electrode and the tip. As the plasma gas flows it will move the electrode and tip apart creating a spark and a pilot arc is then established.

The transfer from pilot to cutting arc occurs when the pilot arc is brought in close to the work piece. This transfer is caused by the electric potential from tip to work via the ionised gas stream.

Another HF free method is via a spring loaded design in the torch head. The trigger is operated and the torch pressed against the material to be cut. This creates a short circuit between the tip and electrode and current starts to flow. As the physical pressure is released the pilot arc is established and the main arc is transferred by proximity to the work piece or via contact cutting where the tip remains in contact with the work piece.

Gas Composition

The plasma cutting process commonly uses oxidising gases, such as air or oxygen. When using these gases the electrode must be copper with a special insert such as hafnium as wear on the electrode is excessive due to oxidation. When either argon, argon-hydrogen or nitrogen is used, the plasma formed is inert and a tungsten electrode is used.

The plasma gas flow is critical and must be set according to the current level needed and the tip bore diameter. If the gas flow is too low for the current level, or the current level too high for the tip bore diameter, the arc will break down forming two arcs in series, electrode to tip and tip to work piece.

The effect of 'double arcing' is usually excessive consumable usage often with the cutting tip melting and electrode damage.

The Plasma Torch

A very important part of the cutting system is the torch. They come in all shapes and sizes both gas and liquid cooled. They can operate with air or in some cases mixed gases. Older type torches tended to be large and heavy but manufacturers have over the years engineered models which are smaller and lighter than the older types but often with a higher capacity. Torches may have an electrical or mechanical pilot arc system as previously described.



Standard Hand Cutting Torch

The torch will have a power/gas connection (in this case the gas used is air), pilot cable and switch connections. All plasma cutting system torches should incorporate a safety circuit involved to prevent operator injury when changing consumables etc. This may be a simple ring circuit that breaks any electrical switching as soon as the retaining cap is removed or could be an air valve which closes when the retaining cap is removed preventing operation. Without such a protection circuit as previously mentioned the open circuit voltage could be as high as 350V DC at the torch head end which is very dangerous. The torch head will encompass the torch electrode, swirl ring for gas distribution in the correct manner, cutting tip and retaining cap.

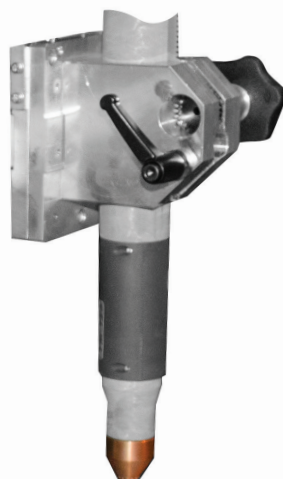

An example of a machine cutting torch

Plasma Cutting Process Variations

Air Plasma Cutting

Air plasma cutting is one of the most common variations used today. It was first introduced in the early 1960's for cutting mild steel. The oxygen present in the air provided additional energy from the exothermic reaction with molten steel. Compared to plasma cutting with nitrogen this additional energy increased cutting speeds by about 25%. When using the air process however, to cut stainless steel and aluminium, the cut surface on these materials can be heavily oxidized, this requires cleaning and is therefore unacceptable for many applications.

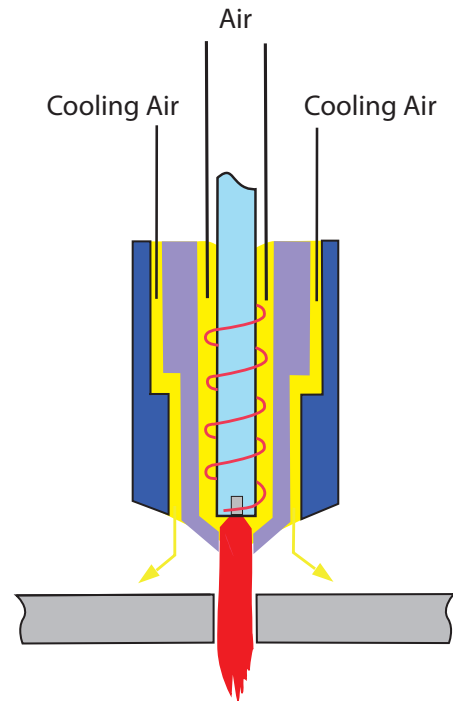

The biggest problem with air cutting has always been the rapid erosion of the plasma torch electrode. Special electrodes were designed made of zirconium, hafnium or hafnium alloy, when tungsten is used it erodes in seconds if the cutting gas contains oxygen as air does. Even with these special materials, electrode life using air plasma is much less than the electrode life associated with conventional inert gas plasma.

Dual Gas

The dual gas process developed by Thermal Dynamics in the early 1960's operates essentially with the same features as conventional plasma cutting except that a secondary gas shield was added around the plasma nozzle. The beneficial effects of the secondary gas are to increase arc constriction and more effective removal of the dross. The plasma gas is normally argon, argon-hydrogen mix or nitrogen and the secondary gas is selected according to the metal being cut.

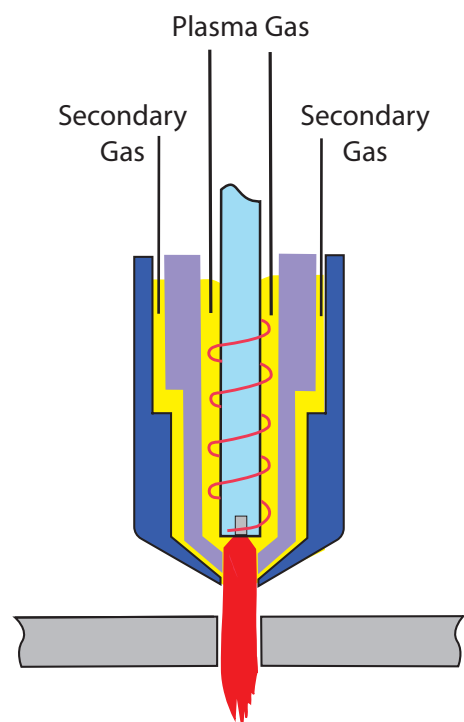

For Example:

Steel: Air, oxygen, nitrogen

Stainless Steel: Nitrogen, argon-hydrogen, CO²

Aluminium: Argon-hydrogen, nitrogen / CO²

The major advantages of dual gas plasma compared with conventional plasma are:

- That the tip can be recessed within a ceramic gas cup or shield cup, preventing the tip from shorting with the workpiece and reducing the tendency for double arcing.
- The shield gas also covers the cutting zone, improving cut quality and speeds as well as cooling the tip and shield cap.

Water Injection

In the water injection plasma cutting process, water is radially injected into the arc in a uniform manner. The radial impingement of the water at the arc provides a higher degree of arc constriction than can be achieved by just the copper nozzle alone. Arc temperatures in this region are estimated to approach 30,000°C or around nine times the surface temperature of the sun and more than twice the temperature of the conventional plasma arc. Unlike the conventional process described earlier, optimum cut quality with water injection plasma is obtained on all metals with just one gas: nitrogen.

This single gas requirement makes the process more economical and easier to use.

Physically, nitrogen is ideal because of its superior ability to transfer heat from the arc to the workpiece. The heat energy absorbed by nitrogen when it dissociates is relinquished when it recombines at the workpiece. Despite the extremely high temperatures at the point where the water impinges the arc, less than 10% of the water is vaporized. The remaining water exits from the tip in the form of a conical spray which cools the top surface of the workpiece. This additional cooling prevents the formation of oxides on the cut surface and efficiently cools the tip at the point of maximum heat load.

The advantages compared with conventional plasma are:

- Improvement in cut quality and squareness of cut
- Increased cutting speeds
- Less risk of 'double arcing'
- Reduction in cutting tip erosion

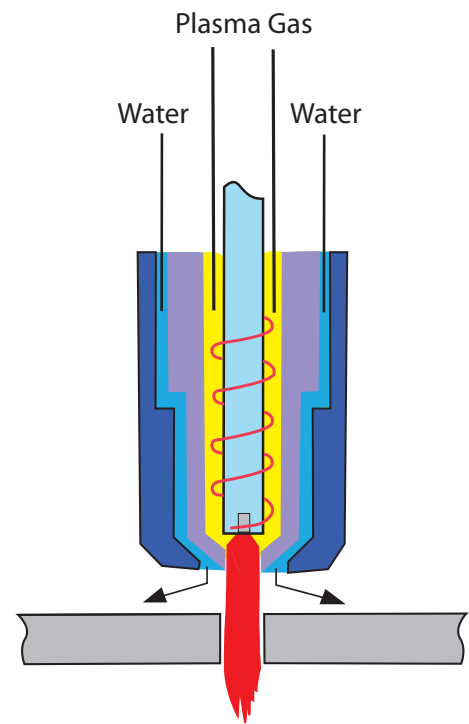

Water Shroud

Water shroud plasma cutting is similar to dual flow except that water is substituted for the secondary shield gas. Cut appearance and tip life are improved because of the cooling effect provided by the water. Cut squareness, cutting speed and dross accumulation are not measurably improved over dual flow plasma cutting because the water does not provide additional arc constriction. The plasma can be operated either with a water shroud or even with the work piece submerged some 50 to 75mm below the surface of the water. Compared with conventional plasma, the water acts as a barrier to provide the following advantages:

- Fume reduction
- Reduction in noise levels
- Improved tip life

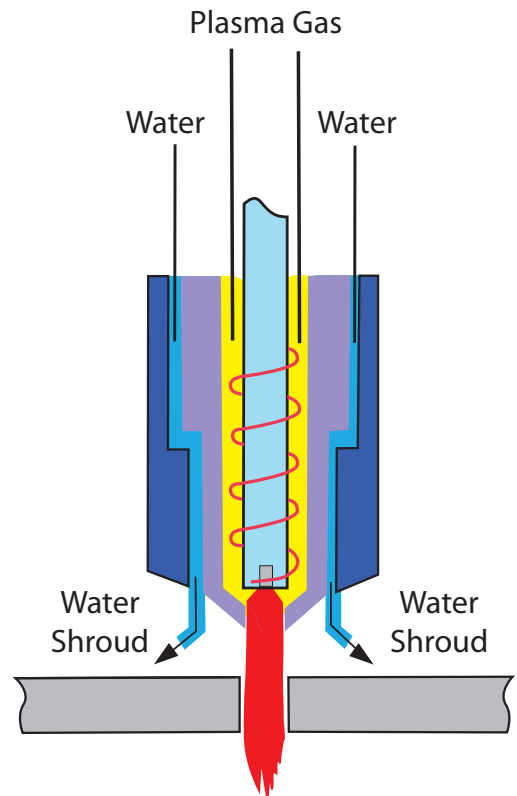

As an example, when cutting at high current levels the typical noise level would be:

- 115 dB – for conventional plasma cutting
- 96 dB – for water shroud plasma cutting
- 52-85 dB – for underwater plasma cutting

High Tolerance Plasma

In an attempt to improve cut quality and to compete with the high cut quality of laser systems, manufacturers have developed high quality and high tolerance systems which operate with a highly constricted plasma stream producing excellent results. By forcing the generated plasma to swirl as it enters the plasma orifice and injecting a secondary flow of gas downstream of the plasma nozzle the plasma is highly focused.

The advantages of the high tolerance plasma cutting system are:

- Cut quality lies between a conventional plasma arc cut and laser beam cut
- Narrow kerf width
- Less distortion due to smaller heat affected zone

The high tolerance plasma cutting system is a technique requiring mechanised precision and high-speed equipment.

The main disadvantages are:

- The maximum thickness is limited
- Cutting speed is generally lower than conventional plasma processes and approximately 60 to 80% the speed of laser cutting.

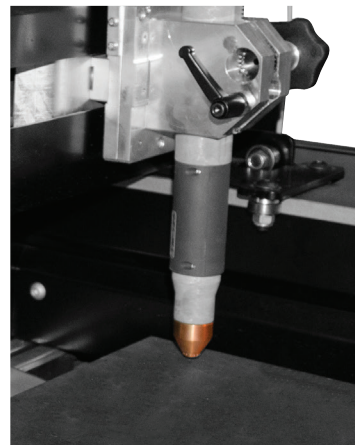
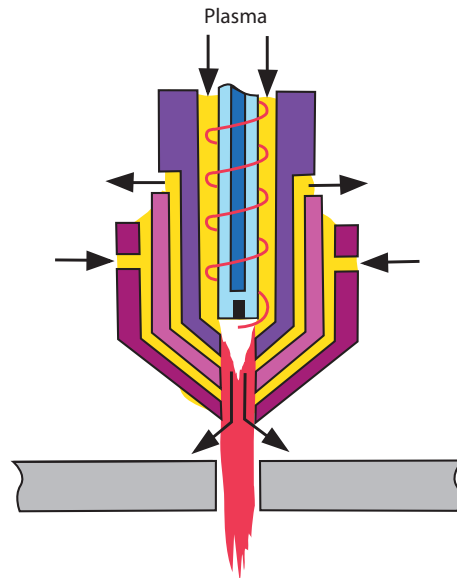

High Quality Cut Samples

Plasma System Gas Supplies

The majority of today's manual hand cutting plasma machines use compressed air as the plasma forming gas although with industrial plasma cutting systems they mixed gas combinations such as oxygen as the plasma gas and compressed air as the shield gas etc. Here are some of the gas options used for plasma cutting for different materials:

Compressed Air

Can be used on all materials. Compressed air is easily accessible and produces relatively fast cuts with good cutting appearance on most materials especially carbon steel. Air is comprised of 20% oxygen and 80% nitrogen (approximately).

The oxygen provides an exothermic reaction with easily oxidized materials such as carbon steel which reduces dross and increases cutting speed. Unfortunately the nitrogen content in air produces a nitriding effect on steel that provides a very hardened surface and the nitride finish can create weld porosity if the raw cut surface is directly welded. When cutting stainless steels with air expect a brown discoloured cut edge this is an oxide layer from the oxygen and this layer can affect some welding processes.

Oxygen

Can only be used on plasma systems that are specifically designed for oxygen use. Oxygen produces the best cut speed, cut quality, and metallurgical finish on carbon steels. Oxygen will cut other materials such as stainless and aluminium but it is not normally used for anything but steel. The edge finish is relatively soft and can be easily welded and machined. Drilling, reaming or tapping of an oxygen plasma cut hole is possible on steel.



Nitrogen

Was the most popular plasma gas up until about 20 years ago when technology improvements in power supply and torch designs allowed the use of air and oxygen as plasma gas. Nitrogen is still used on some older plasma systems that are not designed for air or oxygen use. Nitrogen, if used for cutting carbon steel, will produce a very hard nitrided edge finish, will cut although at slower speeds (as this is simply a thermal process with no exothermic reaction as with oxygen or air), and it is common to experience heavy, hard to remove dross on the bottom of the cut plate. Nitrogen can help to minimize oxidation on stainless steel when either nitrogen or carbon dioxide is used as a shielding gas, or when the plate is submerged under water so that ambient air cannot contact the cut face in the vicinity of the arc. High purity nitrogen, when used with the proper tungsten insert electrode can provide very long electrode life as compared to some air or oxygen cutting systems.

5% Hydrogen/95% Nitrogen

This process is relatively new compared to the above and is used for high quality cutting of stainless steel on materials thinner than 6mm. Each of the above gas mixes should only be used with specific combinations of consumables (Cutting Tips, Electrodes, Swirl Rings, etc.) and flow rates and pressures as recommended by the Plasma Cutting System manufacturer.

35% Hydrogen/65% Argon

This gas is used only on plasma systems that are specifically designed for the use of this gas mixture. This gas is pre-mixed and stored in a high pressure cylinder and it is usually used with a nitrogen shield gas for cutting stainless steel and aluminium over 9.5mm thick.

If this gas mixture is used on thinner stainless steel it will produce a very hard to remove dross. This gas mixture is often used for plasma gouging (metal removal) applications for very good results often replacing carbon arc gouging applications.

PLEASE NOTE

Using oxygen in a plasma torch that was designed for air cutting can cause a serious fire & injury, so the use of an explosive mixture such as Hydrogen/Argon in a system that wasn't designed to use these gases could cause an explosion. Be careful and always follow the manufacturer's instructions.

Compressed Air Supplies

Air compressors have been around for many years, the main reason for their popularity is because air as a resource is clean, easily produced, flexible and convenient although compressors come in a wide variety of different types and sizes, so sizing the appropriate compressor to use with your Plasma Cutting machine is as important as supplying the correct mains power supply.

To get the best out of your plasma cutter you need to supply it with an adequate air supply. The below are suggested questions that need to be considered when specifying an air compressor.

- What is the maximum required operating pressure of the Plasma Cutter?
- What is the maximum required CFM usage of the Plasma Cutter?
- Does the machine need to be portable or stationary?
- What type of drive do you require? Electric Motor or Diesel Engine?
- What receiver tank size will be needed?

Generally 3 phase compressors are considered a better option than single phase compressors.

The accessories used with the compressor are also important, providing the correct air pressure, air flow which is moisture and oil free is crucial in ensuring that your plasma will give you quality cuts.



- Air Hose** Remember to select the correct bore size, considering demand and length.
- Filters** Remove contaminants e.g. water & oil thus prolong tool life.
- Dryers** Refrigerant Dryers, high efficiency heat exchangers.
- Regulators** Allow adjustment to optimum pressure for efficient use of your Plasma Cutter.
Regulate your system to the pressure you need
- Couplings** Heavy air use tools/equipment may need high flow couplings. Size matters.

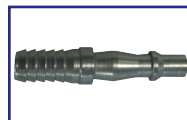
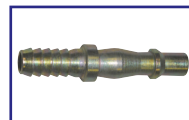
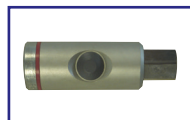
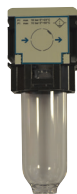

Types of Plasma Cutting

Drag Cutting

Drag cutting is the process of dragging the tip of the torch along the work piece to cut the metal. This is often the easiest way to cut while minimizing heat input but usually only on cutting currents of 40amps and below. Drag cutting does require a 'drag' cutting tip and you need to ensure that the plasma machines output amperage is matched to the amperage with the tip. It can often be helpful to use a non-conductive straight edge to help maintain a straight cut. This technique works best when cutting metal that is less than or equal to 5mm. When you start to drag cut, you would place the tip of the torch on the work piece and begin dragging the tip across the work piece. You should always start with the torch placed at farthest point from you and then cut by pull the torch towards you. Make sure to keep the torch upright to the material being cut throughout the cutting process. As you are drag cutting ensure you maintain a smooth and consistent travel speed to make a clean, precise cut.

Stand-Off Cutting

The stand-off cutting technique is the process of holding the tip of the torch between 3 – 4mm from the work piece to achieve the optimum cut. Stand-off cutting requires a cutting tip that you need to ensure that the plasma machines output amperage is matched to the amperage with the tip.

A stand-off guide, roller guides and circle cutting guide kits can be very helpful in creating the cuts you want. To begin cutting you would place the torch above the work piece of about 3 - 4mm, and begin drawing the tip across the work piece. You should always start with the torch placed at farthest point from you and then cut by pull the torch towards you. Make sure to keep the torch upright to the material being cut throughout the cutting process. As you are cutting ensure you maintain a smooth and consistent travel speed to make a clean, precise cut.

Piercing

Piercing is the process in which a quick hole is made in the work piece. Piercing is often just a starting hole that will be used to make a circular cut within the work piece. You can use standard cutting tips for piercing although ensure the plasma machines output amperage matches the cutting tips amperage rating. No accessories are required when piercing. The thickness of the material to be pierced will need to fall in the proper amperage range for the machine and tip you will be using. There are two different techniques for piercing depending on the thickness of the work piece. If the work piece is less than 2mm sheet metal, the torch should be held at a 15° - 30° angle with the cutting tip touching the work piece. Begin by establishing the pilot arc, as soon as the pilot arc penetrates the work piece, use a smooth, rolling motion to move the torch to a 90° (perpendicular) angle. At this point, the pierce has been created in the work piece allowing you to begin the cutting process. If the material being cut is thicker than 2mm the torch should be held at a 90° (perpendicular) angle approximately 12mm or more above the workpiece.

Begin by establishing the pilot arc and slowly move the torch towards the work piece until the cutting arc transfers.

Once the transfer has occurred, hold the torch still until the arc exits the bottom of the work piece. Once the pierce has been made, the torch can be lowered to normal cutting height and the cutting process can begin.

Bevelling

Bevelling allows you to angle the edge of a flat plate or pipe to allow for deeper weld penetration. This process is normally used for materials that are 9mm or thicker. You can utilize standard cutting tips for bevelling, again you need to ensure you utilize the correct plasma machine amperage to match the cutting tips used. Ensure that the thickness of the material to be bevelled falls in the amperage range of the plasma machine and cutting tip that you will be using. If bevelling by hand a roller and/or angle guide can be helpful in maintaining the consistent bevel face & the desired angle which is usually determined by the weld joint design. The industry standard angle ranges are from 15° - 45°. The cutting tip would normally be between 3 – 6mm from the work piece.

Gouging

Gouging creates a smooth, clean concaved groove within the material being gouged which is often weld ready. This process is primarily used for weld removal or back gouging. Gouging has specific consumables and settings depending on the gouge you need to produce which include the gouging tip and often the shield cup and possibly a gas distributor would be specific to gouging.

To begin the gouging process, hold the tip of the torch approximately 12mm from the work piece angling the torch approximately 20° - 40° to the surface, engage the pilot arc and once established slowly move the tip closer to the work piece until the main arc has transferred. Once the main arc is established, retract the tip until the distance from the work piece to the tip is approximately 15mm. Make sure that you keep the tip of the torch angled approximately 20° - 40° during this entire gouging process. To create a narrow u-groove in the work piece, the operator should maintain a constant, smooth travel speed. With this technique the gouge created will be approximately 6mm wide by 6mm deep but this may depend on the gouging tip profile. To create a wider groove, you can oscillate the plasma torch side to side in a half-moon sequence while maintaining a constant, smooth travel speed. The gouge created will be wider but not as deep. Due to the nature of the gouging process, lead covers, gouging deflectors and torch covers are some accessories that will help to protect the equipment used in the gouging process. Gouging can be done on all conductive materials.

Cut Quality

The quality of the plasma cut edge can be compared to that of cutting using the oxy-fuel process. However, the plasma process cuts by melting the material and therefore a characteristic feature is the greater degree of melting towards the top of the metal resulting in poor edge squareness, top edge rounding or a bevel on the cut edge. As these problems are associated with the degree of constriction of the arc, torch manufacturers are continually developed new torch designs to improve arc constriction and produce a more uniform heating at the top and bottom of the cut to achieve an acceptable cut quality. To help understand cut quality, its best that the characteristics of the finished cut are looked at in close detail, the image shown below will help us explain this.

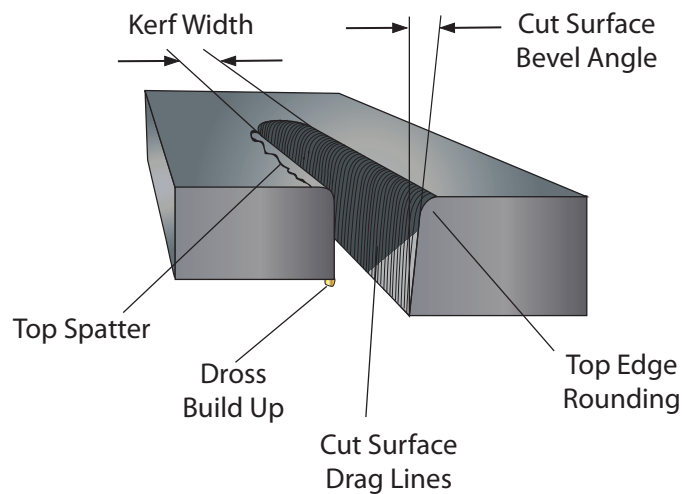

Cutting or Torch Angle

Generally when cutting with a plasma torch, the torch should be held perpendicular to the piece being cut. For mechanically mounted torches, a square can be used to insure that the torch is perpendicular to the plate.

Stand-Off Distance

The distance between the torch tip and the work piece during the cutting process will have an effect on the bevel angles. The greater the distance, the greater the bevel angle will be. Typically, smaller hand cutting systems (40 amps and under) are designed to drag the tip on the plate. For higher amperage hand cutting systems, use of a drag shield cup, a standoff guide, or a cutting guide will help keep a consistent tip to work distance for best results. For automated applications, a device known as an Arc Voltage Control (AVC), can be used. The AVC, also known as a Stand-Off Control or torch height control which will monitor the arc voltage. This voltage directly relates to the tip to work distance. Thinner plate or larger pieces of plate metal can have some deformities that will cause the torch to work distance, over the surface of the plate, to change. Uneven cutting tables or warpage can cause the plate to be higher or lower in relation to the torch as well. The AVC will constantly monitor the arc voltage.

A change in this voltage means a change in torch height. The AVC will raise or lower the torch to keep the stand-off distance constant.

Kerf Width

While plasma cutting a void is left behind which is called The Kerf in the material being cut. This kerf width must be factored into the cutting process so that the cut production part's outside dimensions are not undersized and internal dimensions are not oversized. Cutting amperage and cutting speed play a factor in determining the kerf width. The orifice of the cutting tip is sized according to the amperage. The greater the amperage being used, the larger the tip orifice will be. Typically, the kerf width will be about 2 - 3 times the orifice size of the cutting tip. Cutting speeds are based on the selected amperage for a given material thickness, the arc will always be cutting the leading edge of material directly below torch. Reduced the cutting speed will result in all available material beneath the torch is melted and blown away, the arc will start to reach forward or to the side in order to remain cutting. This will wear the tip causing the orifice to widen. This will result in a wider kerf width, creating more dross and generally giving you a poor cut quality.

Bevel Angle

In an ideal cut, the bevel angle or angle of the cut surface would be perfectly square. The plasma cutting process does result in a slight angle which is called a Bevel Angle, on both the cut and scrap side of the work piece. This is why direction of cut is important. When the plasma gas flows, it has a swirling action as it leaves the cutting tip's orifice. This swirl is generally in a clockwise direction which results in one side of the material being cut being squarer than the other. This means it is very important to consider the travel direction in relation to the piece being cut. In the image below, an circle shaped object is being cut. The inside cut (A) is done in the anti-clockwise direction and the outside cut (B) is done in a clockwise direction.

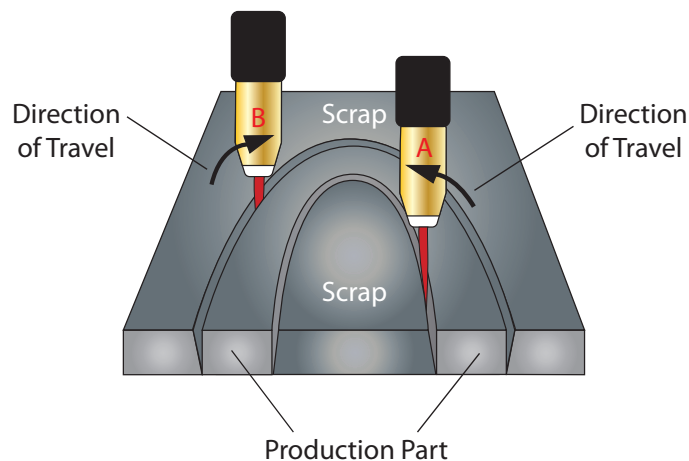

So remember, if you are making a circular cut and plan to keep the inside round piece as your finished work, move in a clockwise direction. If you plan to keep the piece from which the circle was cut from then move in an anti-clockwise direction.

Dross

The formation of dross on the bottom of the plate can be caused when cutting parameters such as speed, amperage, arc voltage, gas pressure/flow and type of gas are not correct for the metal type and thickness being cut. Most commonly, incorrect cutting speeds are to blame for excessive dross. High cutting speeds can result in "high speed dross" that can be very hard to remove without grinding. "Low speed dross" can be easily removed with a brush or chip hammer.

Top Edge Rounding

Is when the top edge of the cut face has eroded away and is not square which is created from the plasma cutting process. It is generally caused when cutting with excessive current or standoff distance. This can be a common occurrence when cutting thickness materials.

Plasma Cutting Problems

The proper installation, application and operation of plasma arc cutting equipment can save many man hours and reduce costs which will give you the promised cut quality and longer consumable parts life.

Cut quality issues or poor consumable life are generally the most experienced problems seen with plasma cutting systems and more often than not are caused by the same thing, for example; low or too high air pressure, low air flow, water or oil in the supply airline will all give you poor cut quality and premature consumable wear. It's often difficult to diagnose cutting issues without understanding the machines use and setup and there are various questions that need to be asked, to be able to give the best advice. Below is listed a few pointers to help you on your way to obtaining consistently good cut quality.

- Ensure your mains power supply is suited to the plasma cutting machines specifications
- Ensure the supplied gases or air supply is in keeping with the requirements of the plasma machine
- Ensure you plasma machines amperage setting matches the cutting tips amperage.
- Clean and service the plasma machine and torch regularly, it's important that the operator watch the torch for signs of contamination or worn consumables being used

Excessive consumable use (short life time of consumables)	Low air pressure or low air flow (or too high)	Check for low air pressure to the plasma machine (low flow can be caused by a long air hose with a small internal diameter or leaks). Ensure your compressor is set to deliver the correct CFM as detailed in the plasma owner's manual and can keep this level maintained during your cutting operation (consider other equipment being used on the same air-line).
	Contaminated gas, Excessive moisture in the air supply	Use a suitable airline filters or air dryers and service them when required. If using a compressor, ensure the receiver is drained regularly.
	Drag cutting at high amperages	Refer to your plasma manual for correct use of cutting tips and their amperage ratings.
	Dragging the cutting tip against a metallic straight edge	Ensure you use a non-metallic straight edge to guide the torch along.
	Excessive piloting	Keeping the pilot arc maintained will erode the consumables much faster than when cutting, keep piloting to a minimum.
Poor Cut Quality	Improper travel speed	Refer to the cutting guide charts within the user manual for the correct settings for material being cut.
	Cutting amperage not correct	Refer to the cutting guide charts within the user manual for the correct settings for material being cut.
	Stand-off height not correct	Refer to the cutting guide charts within the user manual for the correct settings for material being cut.
	Using incorrect torch consumables	Refer to the plasma torch consumable chart within the user manual for the correct settings for material being cut.
	Worn consumables	Check and replace as necessary.
	Plasma not delivering enough output current	Have a technician check the output current of the plasma to ensure its meeting demand.
	Incorrect air pressure or air flow to the machine	Check machines air required within the user manual to ensure air supply meets the requirements. See 'Low air pressure or low air flow (or too high)' above for further information.

PLASMA CUTTING



JASIC

The power in inverter technology

5 Year
Warranty
ON ALL MODELS



0161 793 8127

wilkinsonstar.com