

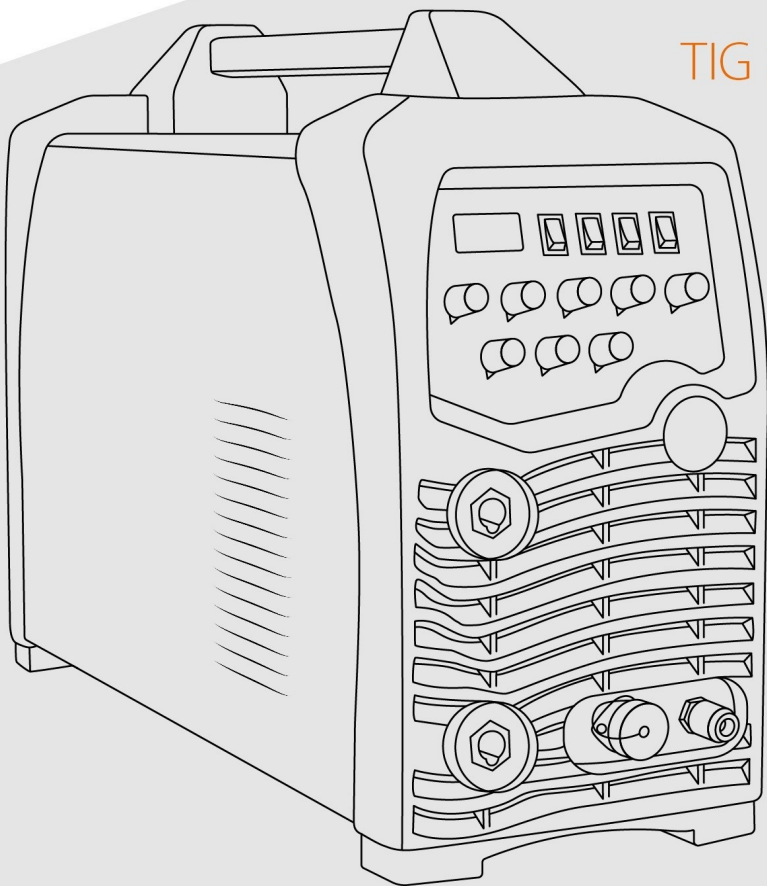

# TIG Series

TIG 200P AC/DC Analog (JT-202A)



# Operator Manual



Intertek

CE

UK  
CA



# Your new product

Thank you for selecting this Jasic product.

This product manual has been designed to ensure that you get the most from your new product. Please ensure that you are fully conversant with the information provided paying particular attention to the safety precautions. The information will help protect yourself and others against the potential hazards that you may come across.

Please ensure that you carry out daily and periodic maintenance checks to ensure years of reliable and trouble free operation.

Please call your Jasic distributor in the unlikely event of a problem occurring.

Please record below the details from your product as these will be required for warranty purposes and to ensure you get the correct information should you require assistance or spare parts.

Date purchased \_\_\_\_\_

From where \_\_\_\_\_

Serial number \_\_\_\_\_

(The serial number is normally located on the top or underside of the machine and will begin with AA).

For further information on your Jasic product warranty registration please visit:

[www.jasic-warranty.co.uk](http://www.jasic-warranty.co.uk)

## **Disclaimer**

Whilst every effort has been made to ensure that the information contained within this manual is complete and accurate, no liability can be accepted for any errors or omissions.

Please note:

Products are subject to continual development and may be subject to change without notice.

Regularly check our product pages at [www.Jasic.co.uk](http://www.Jasic.co.uk) for revision updated operating manuals.

No part of this manual may be copied or reproduced by any means without the written permission of Wilkinson Star Limited.

# CONTENTS

<b>Index</b>	<b>Page</b>
Your New Product	2
Index	3
Safety Instructions	4
General electrical safety	4
General operating safety	4
PPE	5
Welding processes lens shade selector guide	5
Fume and welding gases	6
Fire risks	6
The working environment	7
Protection from moving parts	7
Magnetic fields	7
Compressed gas cylinders and regulators	7
RF declaration	8
LF declaration	8
Materials and their disposal	8
Product Overview	9
Technical Specifications	10
Description of Controls	11
Installation	14
Operation MMA	21
Guide to MMA Welding	26
MMA Welding Problems	30
Operation DC TIG	31
Operation AC TIG	35
TIG Torch Trigger Modes	38
Remote Control Socket	39
Guide to TIG Welding	40
Guide to DC TIG Welding	44
Guide to AC TIG Welding	46
TIG Welding Torch	51
TIG Welding Problems	52
Maintenance	54
Service Schedule Record	54
Troubleshooting	55
WEEE Disposal	56
RoHS Compliance Declaration	56
UKCA Declaration of Conformity	56
EC Declaration of Conformity	57
Statement of Warranty	58
Options and Accessories	59
Schematics	60
Notes	61
Jasic Contact Details	62

# SAFETY INSTRUCTIONS

These general safety norms cover both arc welding machines and plasma cutting machines unless otherwise noted.

It is important that users of this equipment protect themselves and others from harm or even death. The equipment must only be used for the purpose it was designed for. Using it in any other way could result in damage or injury and in breach of the safety rules.

Only suitably trained and competent persons should use the equipment.

Pacemaker wearers should consult their doctor prior to using this equipment.

PPE and workplace safety equipment must be compatible for the application of the work involved.

**Always carry out a risk assessment before undertaking any welding or cutting activity**

## General electrical safety



The equipment should be installed by a qualified person and in accordance with current local electrical safety standards. It is the users responsibility to ensure that the equipment is connected to a suitable power supply. Consult with your utility supplier if required.

Do not use the equipment with the covers removed.

Do not touch live electrical parts or parts which are electrically charged.

Turn off all equipment when not in use.

In the case of abnormal behaviour of the equipment, the equipment should be checked by a suitably qualified service engineer.

If earth bonding of the work piece is required, bond it directly with a separate cable with a current carrying capacity capable of carrying the maximum capacity of the machine current.

Cables (both primary supply and welding) should be regularly checked for damage and overheating.

Never use worn, damaged, under sized or poorly jointed cables.

Insulate yourself from work and earth using dry insulating mats or covers big enough to prevent any physical contact.

Never touch the electrode if you are in contact with the work piece return.

Do not wrap cables over your body.

Ensure that you take additional safety precautions when you are welding in electrically hazardous conditions such as damp environments, wearing wet clothing and metal structures.

Try to avoid welding in cramped or restricted positions.

Ensure that the equipment is well maintained. Repair or replace damaged or defective parts immediately.

Carry out any regular maintenance in accordance with the manufacturers instructions.

The EMC classification of this product is class A in accordance with electromagnetic compatibility standards CISPR 11 and IEC 60974-10 and therefore the product is designed to be used in industrial environments only.

**WARNING:** This class A equipment is not intended for use in residential locations where the electrical power is provided by a public low-voltage supply system. In those locations it may be difficult to ensure the electromagnetic compatibility due to conducted and radiated disturbances.

## General operating safety

Never carry the equipment or suspend it by the carrying strap or handles during welding.

Never pull or lift the machine by the welding torch or other cables. Always use the correct lift points or handles. Always use the transport under gear as recommended by the manufacturer.

Never lift a machine with the gas cylinder mounted on it.

If the operating environment is classified as dangerous, only use S-marked welding equipment with a safe idle voltage level. Such environments may be for example: humid, hot or restricted accessibility spaces.

# SAFETY INSTRUCTIONS

## Use of Personal Protective Equipment (PPE)

Welding arc rays from all welding processes produce intense, visible and invisible (ultraviolet and infrared) rays that can burn eyes and skin.

- Wear an approved welding helmet fitted with an appropriate shade of filter lens to protect your face and eyes when welding or watching.
- Wear approved safety glasses with side shields under your helmet.
- Never use broken or faulty welding helmets.
- Always ensure there are adequate protective screens or barriers to protect others from flash, glare and sparks from the welding area.
- Ensure that there are adequate warnings that welding or cutting is taking place.
- Wear suitable protective flame resistant clothing, gloves and footwear.
- Check and be sure the area is safe and clear of inflammable material before carrying out any welding.

Some welding and cutting operations may produce noise. Wear safety ear protection to protect your hearing if the ambient noise level exceeds the local allowable limit (e.g: 85 dB).



## Welding and Cutting Lens Shade Selector Guide

CURRENT	MMA ELECTRODES	MIG LIGHT ALLOYS	MIG HEAVY METALS	MAG	TIG ON ALL METALS	PLASMA CUTTING	PLASMA WELDING	GOUGING ARC/AIR
10	8							
15								
20	9	10	10	10	10			
30								
40	10					11	11	10
60								
80	11	11		11	11			
100								
125	12	12	11	12	12			
150								
175	13	13		13				
200								
225	14	14	13	14	13	12	13	11
250								
275	15	15						12
300								
350	13	14	13	14	14	13	14	13
400								
450	14	15	14	15				14
500								

# SAFETY INSTRUCTIONS

## Safety against fumes and welding gases



**Warning**  
Fumes and  
Gases

The HSE have identified welders as being an 'at risk' group for occupational diseases arising from exposure to dusts, gases, vapours and welding fumes. The main identified health effects are pneumonia, asthma, chronic obstructive pulmonary disease (COPD), lung and kidney cancer, metal fume fever (MFF) and lung function changes.

During welding and hot cutting 'hot work' operations, fumes are produced which are collectively known as welding fume. Depending upon the type of welding process being performed, the resultant fume generated is a complex and highly variable mixture of gases and particulates.

Regardless of the length of welding being carried out, all welding fume, including mild steel welding, requires suitable engineering controls to be in place which is usually Local Exhaust Ventilation (LEV) extraction to reduce the exposure to welding fume indoors and, where LEV does not adequately control exposure, it should also be enhanced by using suitable respiratory protective equipment (RPE) to assist with protecting against residual fume.

When welding outdoors appropriate RPE should be used.

Prior to undertaking any welding tasks an appropriate risk assessment should be carried out to ensure expected control measures are in place.

Locate the equipment in a well-ventilated position and keep your head out of the welding fume.

Do not breathe the welding fume.

Ensure the welding zone is well-ventilated and provision should be made for suitable local fume extraction system to be in place.

If ventilation is poor, wear an approved airfed welding helmet or respirator.

Read and understand the Material Safety Data Sheets (MSDS's) and the manufacturer's instructions for metals, consumables, coatings, cleaners and de-greasers.

Do not weld in locations near any de-greasing, cleaning or spraying operations.

Be aware that heat and rays of the arc can react with vapours to form highly toxic and irritating gases.

**For further information please refer to the HSE website [www.hse.gov.uk](http://www.hse.gov.uk) for related documentation.**

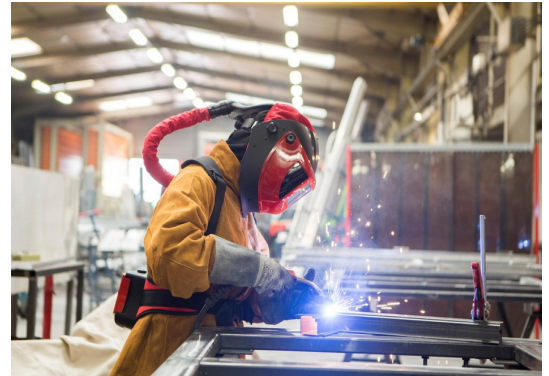

An example of personal fume protection

## Precautions against fire and explosion



**Warning**  
Fire Risk

Avoid causing fires due to sparks and hot waste or molten metal.

Ensure that appropriate fire safety devices are available near the welding and cutting area.

Remove all flammable and combustible materials from the welding, cutting and surrounding areas.

Do not weld or cut fuel and lubricant containers, even if empty. These must be carefully cleaned before they can be welded or cut.

Always allow the welded or cut material to cool before touching it or placing it in contact with combustible or flammable material.

Do not work in atmospheres with high concentrations of combustible fumes, flammable gases and dust.

Always check the work area half an hour after cutting to make sure that no fires have begun.

Take care to avoid accidental contact of electrode to metal objects. This could cause arcs, explosion, overheating or fire.



## **Understand your fire extinguishers**

# SAFETY INSTRUCTIONS

## The working environment

Ensure the machine is mounted in a safe and stable position allowing for cooling air circulation.

Do not operate equipment in an environment outside the laid down operating parameters.

The welding power source is not suitable for use in rain or snow.

Always store the machine in a clean, dry space.

Ensure the equipment is kept clean from dust build up.

Always use the machine in an upright position.

## Protection from moving parts

When the machine is in operation keep away from moving parts such as motors and fans.

Moving parts, such as the fan, may cut fingers and hands and snag garments.

Protections and coverings may be removed for maintenance and controls only by qualified personnel after first disconnecting the power supply cable.

Replace the coverings and protections and close all doors when the intervention is finished and before starting the equipment.

Take care to avoid getting fingers trapped when loading and feeding wire during set up and operation.

When feeding wire be careful to avoid pointing it at other people or towards your body.

Always ensure machine covers and protective devices are in operation.

## Risks due to magnetic fields



The magnetic fields created by high currents may affect the operation of pacemakers or electronically controlled medical equipment.

Wearers of vital electronic equipment should consult their physician before beginning any arc welding, cutting, gouging or spot welding operations.

Do not go near welding equipment with any sensitive electronic equipment as the magnetic fields may cause damage.

Keep the torch cable and work return cable as close to each other as possible throughout their length.

This can help minimise your exposure to harmful magnetic fields.

Do not wrap the cables around the body.

## Handling of compressed gas cylinders and regulators

### Mishandling gas cylinders can lead to rupture and the release of high pressure gas.



Always check the gas cylinder is the correct type for the welding to be carried out.

Always store and use cylinders in an upright and secure position.

All cylinders and pressure regulators used in welding operations should be handled with care.

Never allow the electrode, electrode holder or any other electrically “hot” parts to touch a cylinder.

Keep your head and face away from the cylinder valve outlet when opening the cylinder valve.

Always secure the cylinder safely and never move with regulator and hoses connected.

Use a suitable trolley for moving cylinders.

Regularly check all connections and joints for leaks.

Full and empty cylinders should be stored separately.

### Never deface or alter any cylinder

# SAFETY INSTRUCTIONS

## RF Declaration

Equipment that complies with directive 2014/30/EU concerning electromagnetic compatibility (EMC) and the technical requirements of EN60974-10 is designed for use in industrial buildings and not those for domestic use where electricity is provided via the low voltage public distribution system.

Difficulties may arise in assuring class A electromagnetic compatibility for systems installed in domestic locations due to conducted and radiated emissions.

In the case of electromagnetic problems, it is the responsibility of the user to resolve the situation.

It may be necessary to shield the equipment and fit suitable filters on the mains supply.

## LF Declaration

Consult the data plate on the equipment for the power supply requirements.

Due to the elevated absorbance of the primary current from the power supply network, high power systems affect the quality of power provided by the network. Consequently, connection restrictions or maximum impedance requirements permitted by the network at the public network connection point must be applied to these systems.

In this case, the installer or the user is responsible for ensuring the equipment can be connected, consulting the electricity provider if necessary.

## Materials and their disposal

Welding equipment is manufactured with BSI published standards meeting CE requirements of materials which do not contain any toxic or poisonous materials dangerous to the operator.

Do not dispose of the equipment with normal waste. The European Directive 2012/19/EU on Waste Electrical and Electronic Equipment states that electrical equipment that has reached its end of life must be collected separately and returned to an environmentally compatible recycling facility for disposal.

**For more detailed information please refer to the HSE website [www.hse.gov.uk](http://www.hse.gov.uk)**



## PRODUCT OVERVIEW

The Jasic TIG inverter range of welding machines have been designed as integrated and portable welding power supply units incorporating the most advanced IGBT inverter technology in power electronics with easy operation and adjustment due to a friendly user interface.

Unique electric structure and air channel design in this series of machines can speed up the heat dissipation of the power device as well as improving the duty cycles of the machines. The unique heat rejection efficiency of the air channel can effectively prevent the power devices and control circuits from being damaged by the dust absorbed by the fan and thereby, the reliability of the machine is greatly improved.

The front panel and the rear panel of the machine and the handle are coated with rubber oil, so the machine has a soft texture, good hand feeling that feels warm and comfortable to hold.

### Jasic TIG 202A Analog AC/DC Product Features:

- Compact, lightweight and modern design
- DC pulse TIG with excellent HF arc ignition which offers high reliability arc starting
- Suitable for a wide range of DC MMA welding electrodes
- Advanced IGBT inverter technology
- 43Khz inverter frequency, high efficiency
- 2T/4T trigger control
- Fully adjustable pre and post gas flow time with adjustable down slope current control in TIG mode
- Pulse frequency adjustment control
- Adjustable AC frequency and wave balance control
- Built in arc force technology which maintains the optimum MMA arc conditions during operation even with long welding cables
- Offers excellent weld characteristics and suitable for a wide range of electrodes in MMA
- Easy arc starting, low spatter, stable current which offers good weld bead shape
- Wide input voltage range tolerance
- Remote control options available
- Inbuilt VRD (7V output available, please contact your supplier for activation procedure)
- **Can easily be upgraded to a water cooled package**



## TECHNICAL SPECIFICATIONS

Technical Parameter		Unit	TIG 202A Analog AC/DC
Rated input voltage		V	1ph 230V AC 50/60Hz
Input current I <sub>eff</sub> TIG		A	16
Input current I <sub>eff</sub> MMA		A	17
I Max TIG		A	30
I Max MMA		A	31
Input power		kVA	6.9
Welding current range - TIG (AC / DC)		A	DC 5 ~ 200 / AC 5 ~ 200
Welding current range - MMA (AC / DC)		A	DC 10 ~ 160 / AC 10 ~ 160
Duty cycle - MMA		%	160 @ 30%
Duty cycle - TIG		%	200 @ 25%
No load voltage	MMA	V	65 (VRD 7V)
	TIG		65 (VRD 7V)
Pre flow time		S	0 ~ 10
Background current (pulse mode)		%	10 ~ 100
AC output frequency		Hz	20 ~ 250
AC balance (AC balance zero point is approx. 5)		scaled	1 ~ 10
Pulse frequency		Hz	1 ~ 200
Downslope time		S	0 ~ 10
Post flow time		S	0.5 ~ 20
Efficiency		%	80
Idle State Power		W	< 50
Housing protection grade		IP	21S
Power factor		cosφ	0.7
Insulation grade		-	B
Arc ignition mode		-	HF arc ignition
Standard		-	IEC60974-1
Noise		Db	<70
Operating temperature		°C	-10 ~ +40
Store temperature		°C	-25 ~ +55
Size (Power source only)		mm	566 x 224 x 405
Weight (Power source only)		Kg	15
Remote control option		-	Yes

### Please Note

Due to variations in manufactured products, all claimed performance ratings, capacities, measurements, dimensions and weights quoted are approximate only. Achievable performance and ratings when in use can depend upon correct installation, applications and use, along with regular maintenance and service.



# CONTROLS

## Control panel view Jasic TIG 202A AC/DC Analog

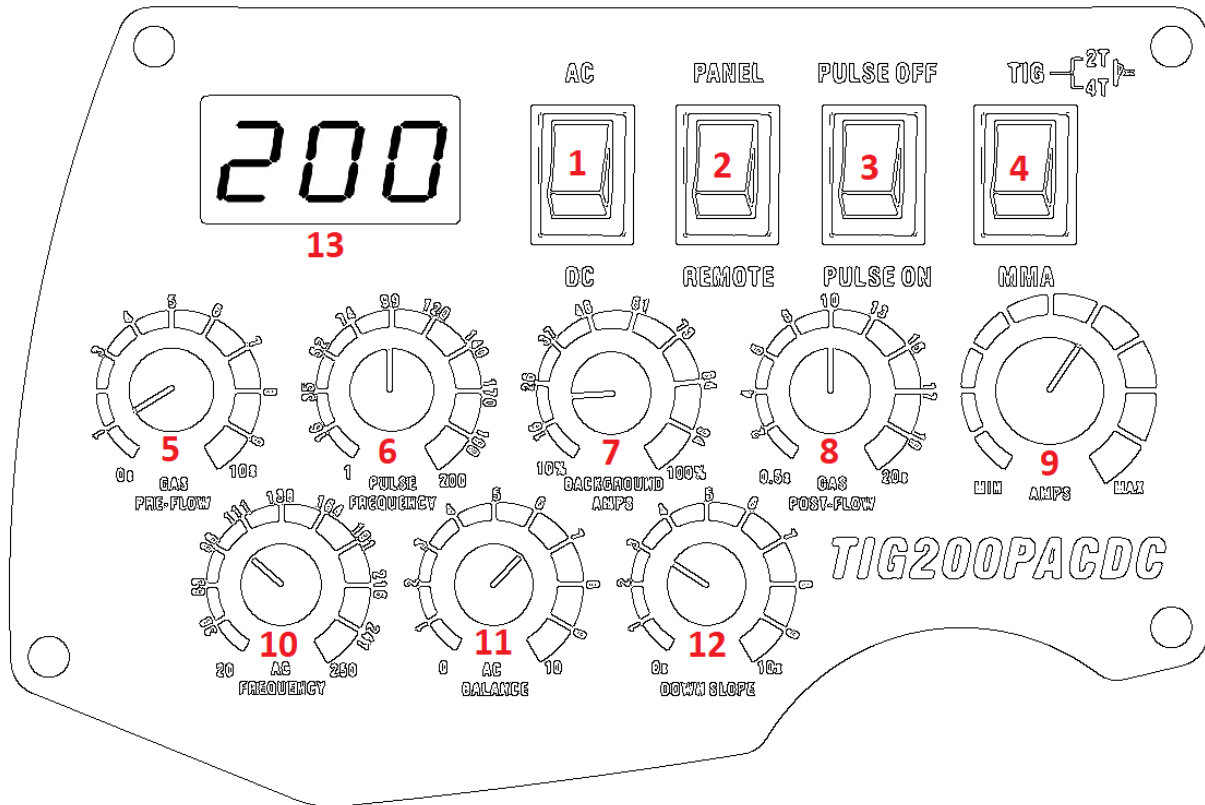

1. Welding voltage output selection: Using this switch will select either DC or AC output voltage when in MMA or TIG welding mode depending on your requirements.
2. Remote control selection: Pressing this switch will set current control from the panel or to a remote device such as a foot pedal.
3. Pulse on/off selection switch: Allows the user to select either TIG pulse on or off
4. Welding process and 2T/4T selection switch: Pressing this button will allow the operator to switch between MMA or TIG mode. Also allows the user to select 2T or 4T TIG torch trigger mode.
5. Pre flow gas timer control: This is the time the gas will flow prior to welding to purge the torch gas line. Adjustment range is 0 ~ 10 seconds.
6. Pulse frequency control: This control allows the setting of the pulse frequency (pulses per second) when in the pulse welding mode. Adjustment range is 1 ~ 200 Hz.
7. Background current adjustment during pulse mode only. Adjustment range is 10 ~ 100%.  
For example, a peak current of 100A and background current set at 30% means the welding current will go from 100A to 30A during each pulse cycle.
8. Post gas timer control. This controls the time the gas will flow after the arc is extinguished. This gas flowtime protects the weld zone and electrode from contamination during cooling. Adjustment range is 0 ~ 20 seconds.

# CONTROLS

## Control panel view Jasic TIG 202A AC/DC Analog—continued

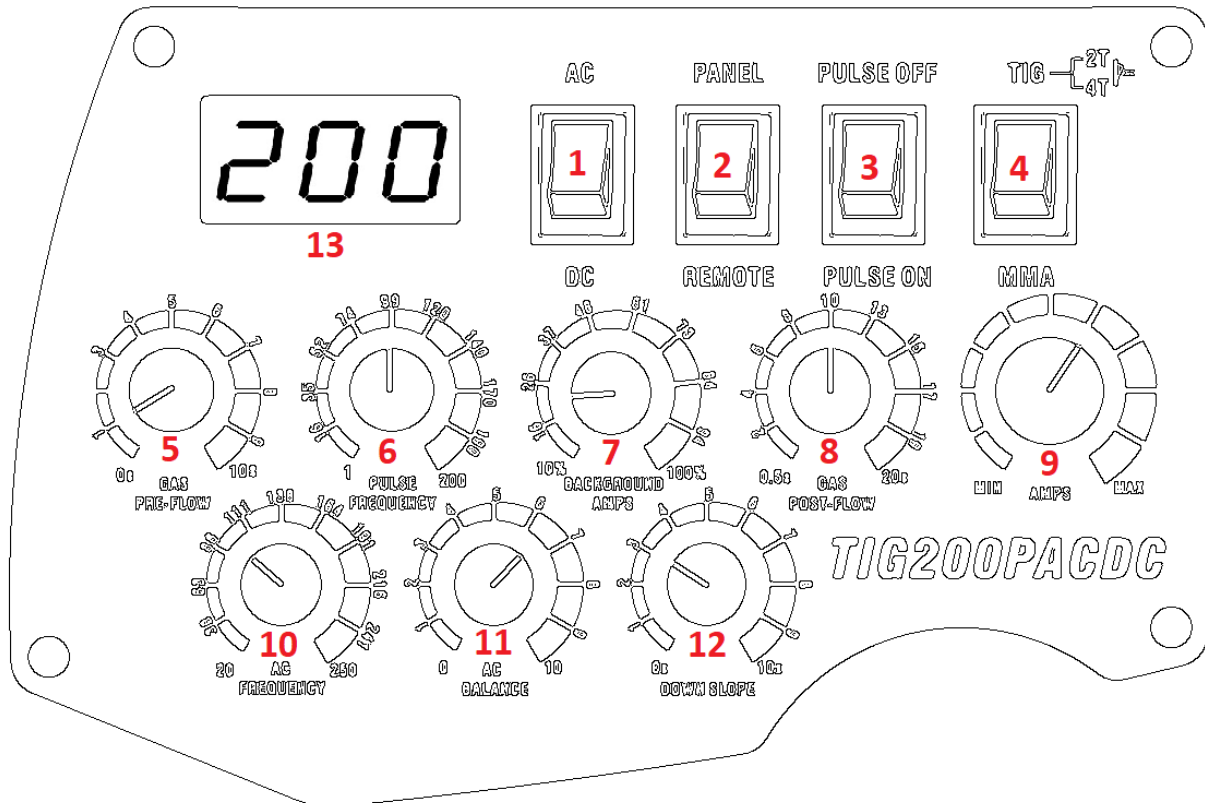

9. Welding current adjustment (peak current when in pulse mode). Adjustment range is 10 ~ 200.
10. AC Frequency control: Allows the user to adjust the AC frequency setting by rotating this control dial. The adjustment AC frequency range is 20 ~ 250Hz.
11. Cleaning control (AC mode): When welding materials with a refractory oxide surface such as aluminium, this oxide needs to be removed to allow welding of the base material. In the AC mode the oxide is removed during the positive half of the AC wave. This control allows setting of the amount of time between positive and negative. The control can set the amount of time in the positive (cleaning time) of the cycle. The higher the setting the more aggressive the cleaning action but more time in the positive cycle drives more energy into the tungsten so care should be taken to avoid overheating the tungsten. Adjustment range is 1 ~ 10.
12. Downslope timer control: This is the time the current will take to reduce at the end of the weld. This helps eliminate craters or pin holes forming. Adjustment range is 0 ~ 10 seconds.
13. Digital display meter: Displays actual current before and during welding as well as other parameter settings. Also used to display any error message codes.

# INSTALLATION

## Unpacking

Check the packaging for any signs of damage.

Carefully remove the machine and retain the packaging until the installation is complete.

## Location

The machine should be located in a suitable position and environment. Care should be taken to avoid moisture, dust, steam, oil or corrosive gases.

Place on a secure level surface and ensure that there is adequate clearance around the machine to ensure natural airflow.

## Input connection

Before connecting the machine you should ensure that the correct supply is available.

Details of the machine requirements can be found on the data plate of the machine or in the technical parameters shown in the manual.

The equipment should be connected by a suitably qualified competent person. Always ensure the equipment has a proper grounding.

**Never connect the machine to the mains supply with the panels removed.**

## Output connections

### Electrode polarity

In general when using manual arc welding electrodes the electrode holder is connected to the positive terminal and the work return to the negative terminal.

"+" output terminal: For MMA connect the electrode holder

"-" output terminal: For MMA connect the work return lead

Always consult the electrode manufacturer's data sheet if you have any doubts.

When using the machine for TIG welding the TIG torch should be connected to the negative terminal and the work return to the positive terminal.

"+" output terminal: For TIG connect the work return lead

"-" output terminal: For TIG connect the TIG torch

### Gas connections

Connect the gas hose to the regulator or flowmeter located on the shield gas cylinder and connect the other end of the gas hose to the input gas connection on the machine.

### Please Note:

Check these power connections daily to ensure they have not become loose otherwise arcing may occur when used under load.

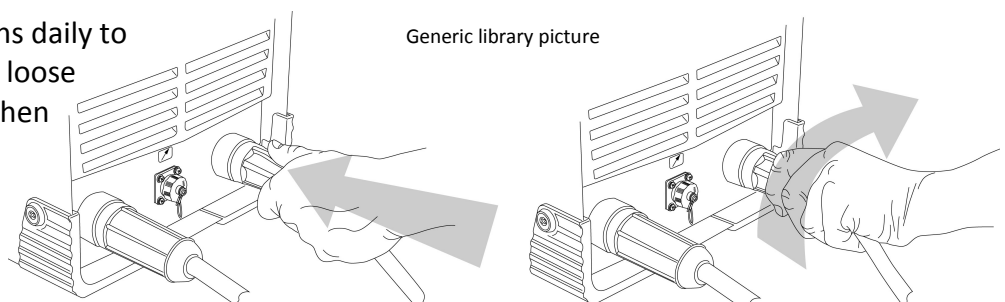

# INSTALLATION

## MMA welding

Insert the cable plug for the electrode holder into the “+” socket on the front panel of the welding machine and tighten it clockwise.

Insert the cable plug for the work return lead into the “-” socket on the front panel of the welding machine and tighten it clockwise.

See example of the MMA setup as shown.

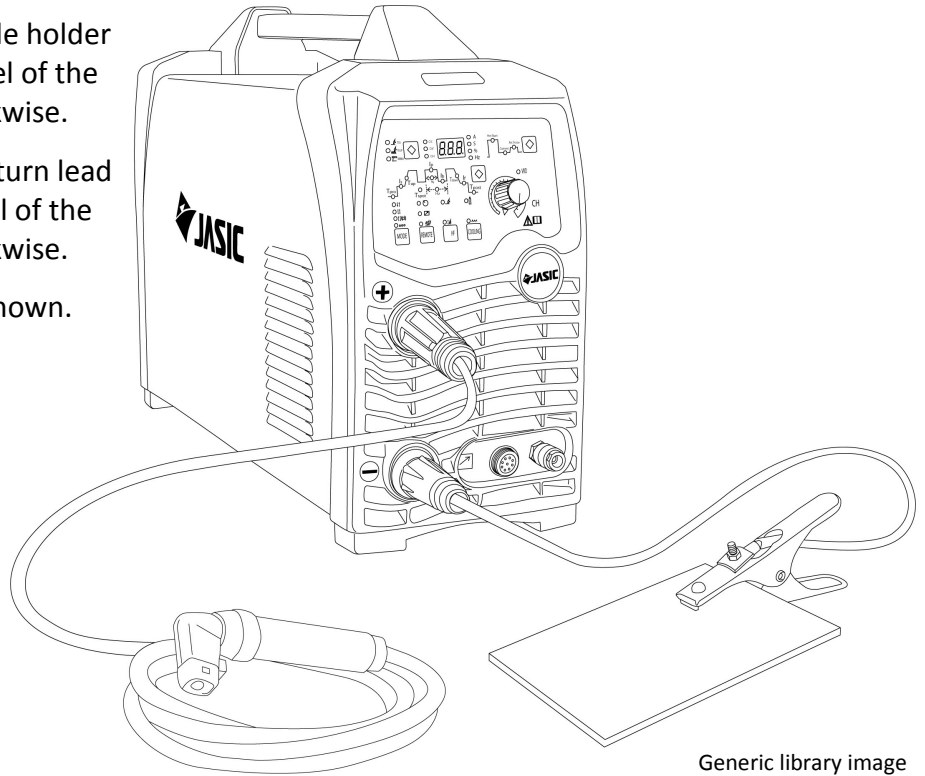

Generic library image

## TIG welding

Insert the cable plug for the work clamp into the “+” socket on the front panel of the welding machine and tighten it clockwise.

Insert the cable plug of the TIG torch into the “-” socket on the front panel of the machine and tighten clockwise.

Connect the gas quick connector into the outlet on the machine front.

Connect the torch switch plug into the socket on the front panel.

Connect the gas hose to the regulator or flowmeter located on the shield gas cylinder and connect the other end to the machine.

See example of the TIG setup as shown.

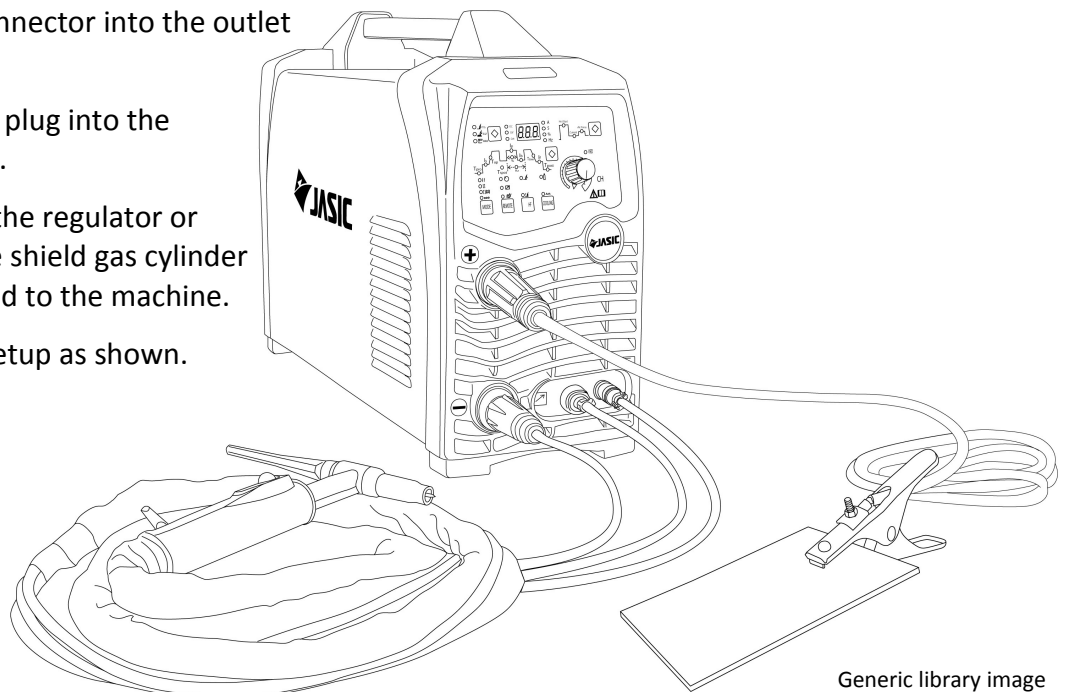

Generic library image

# INSTALLATION

## WATER COOLED TIG TROLLEY PACKAGE COMPATABILITY

These assembly instructions are suitable for the following Jasic TIG welding packages:

JT-202A-WC

JT-202D-WC

JT-300P-WC

JT-315MWD-WC

## CONTENTS

Check the trolley packaging for any signs of damage.

Carefully remove all the components, check that all parts are present and retain the packaging until the assembly is complete.

### Kit Contents:

1 x Base Unit (assembled)

2 x Cylinder Chain/Straps

2 x Side fixing brackets

1 x Upright Cylinder Support

2 x Top Shelf Brackets

1 x Top unit (with handle)

6 x M5 Screws

10 x M10 Screws

12 x M6 Screws

**Please Note:** This kit is used for other machine packages, you may note that extra screws are supplied and as a result there may be some screws left over once you have fully assembled the trolley package.

For the following instructions we have used the Jasic JT-315 ACDC Multi Wave TIG power source and cooler as shown below.





# INSTALLATION

## WATER COOLED TIG TROLLEY PACKAGE CONTENTS

The below shows the main contents of the TIG trolley assembly kit.

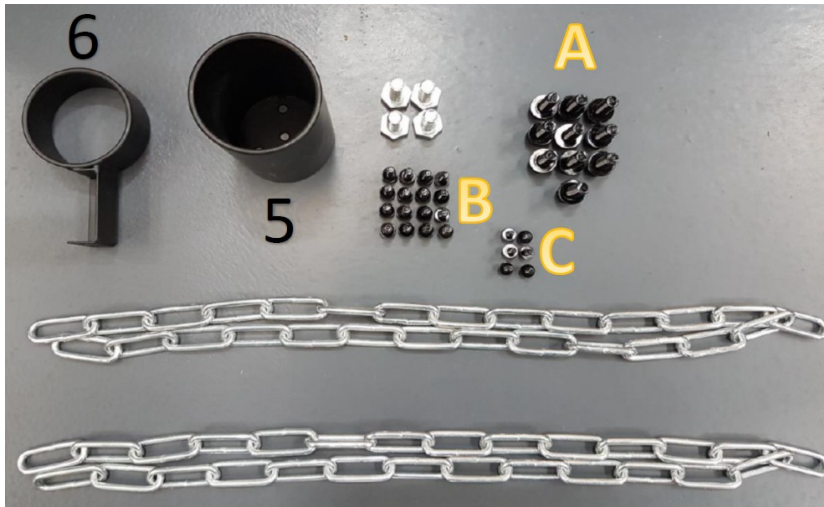

Various sundry items (required for assembly)

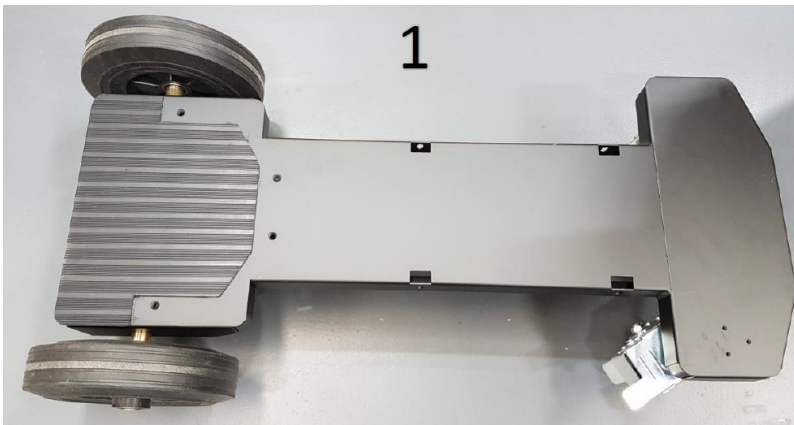

Base unit (item 1) including assembled wheels

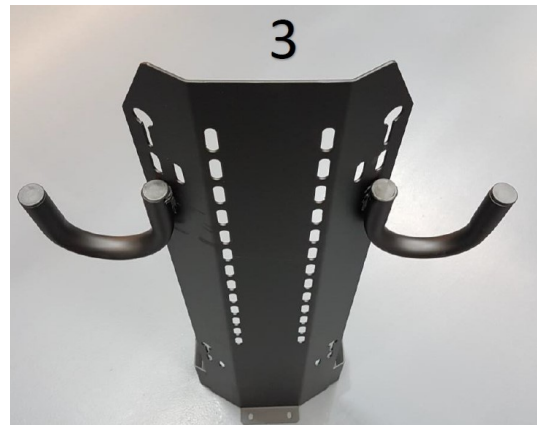

Upright Cylinder Support (item 3)

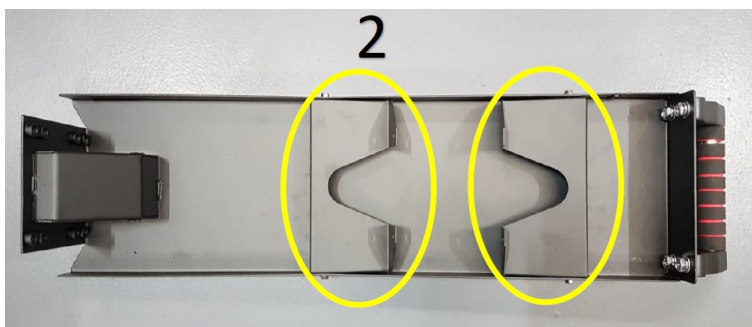

Top shelf (item 2) also showing circled top shelf brackets



Side fixing brackets (item 4)

# INSTALLATION

## WATER COOLED TIG TROLLEY PACKAGE ASSEMBLY

- 1 Place the base unit on a flat surface, locate the cylinder support (Item 3) and use M10 screws (A) to fix the cylinder support to the base unit (item1).



- 2 Locate the cooler base brackets (circled yellow) which secures the water cooler to the base unit. (brackets supplied with cooler)



- 3 Place the cooler on its side and mount the two brackets supplied with the water cooler (circled yellow) to the bottom of the cooler as shown using the screws (B) supplied with the cooler. Please Note: Fit the front bracket to the holes that are more central on the bottom of the cooler.

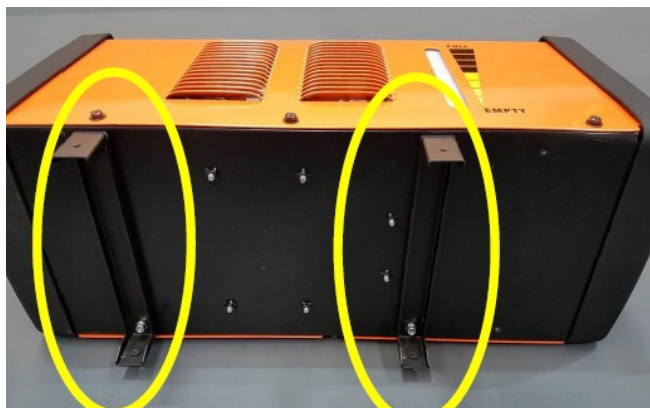

- 4 Mount and fix the water cooler to the base unit (item 1) using the supplied qty 4 screws (B).



## INSTALLATION

### WATER COOLED TIG TROLLEY PACKAGE ASSEMBLY

- 5 Fit the two side brackets (item 4) to the water cooler as shown below.



- 6 Fit the TIG wire 'cup' (item 5) to the base using the supplied 3 screws (C)



- 7 Remove the bottom side front and rear screws either side of the power source (the middle screw may not be required to be removed) and mount the power source on top of the water cooler lining up the holes of the bracket. (The bracket should be on the outside of the power source panel). Secure the power source with the screws that were removed.



# INSTALLATION

## WATER COOLED TIG TROLLEY PACKAGE ASSEMBLY

- 8 Remove the top brackets shown with item 2 and fit to the top of the power source as shown below. Use the screws you have removed from the power source lid to fix the two brackets in place.



- 9 Mount the top shelf (item 2) on top of the fitted brackets and use the screws removed earlier to fix the top shelf in place. Also secure the top shelf (item 2) to the cylinder upright (item 3) with screws (A).



10. Fix (item 6) which assists holding the TIG wire in place, to the top panel (item 2) as shown below using two screws ©, a 7mm spanner may be required to assist with fastening this accessory in place.

11. Fit the supplied bottle chains (as shown below) through the relevant slots on item 3 and the assembly is now complete.



12. Connect the water cooler power plug to the control socket on the rear panel of the TIG power source.  
13. Check the relevant TIG machine operating manual for instructions for fitting a water cooled TIG torch.

## OPERATION - MMA



Before starting any welding activity ensure that you have suitable eye protection and protective clothing. Also take the necessary steps to protect any persons within the welding area.

### The Process

MMA (Manual Metal Arc), SMAW (Shielded Metal Arc Welding) or just Stick Welding.

The manual metal arc process was first developed in Russia in 1888 and comprised a bare metal welding rod. In the early 1900's the coated electrode was invented and introduced in Sweden. In the UK the Quasi arc method was introduced. The use of the coated electrode was slow due to the high production costs but the demand for higher integrity welds led to the process becoming increasingly used.

The material is joined when an arc is created between the electrode and work piece melting the work piece and the electrode to form a weld pool.

At the same time the electrode has an outer coating sometimes called electrode flux which also melts and creates a shield over the weld pool to prevent contamination of the molten pool and assist in establishing the arc. This cools and forms a hard slag over the weld which then needs to be chipped away from the weld bead upon completion or before another weld bead is added.

The process allows only short lengths of weld to be produced due to the electrode length before a new electrode needs to be inserted in the holder. The quality of the weld deposit is highly dependent on the skill of the welder.

The power source provides a constant current (CC) output and can be either AC (alternating current) or DC (direct current).

The design of a MMA power source is such that when the operator extends the arc length it will reduce the welding current and shortening the arc length (reducing the arc voltage) will do the opposite i.e. increase the current. As a guide, the voltage controls the height and width of the weld bead whilst the current controls penetration, therefore the welder manipulates the electrode to achieve a satisfactory weld.

The power used in the welding circuit is determined by the arc voltage and current. The voltage (V) is determined by the electrode diameter and the distance between the electrode and work piece. The current within the circuit is dependent on the electrode diameter, the thickness of the materials to be welded and the position of the weld. Most electrode information will show details of current types to be used and optimum current range.

MMA welding power sources which can TIG weld are often referred to as drooper's or drooping characteristic power sources. They are typically basic selector type, magnetic amplifier control or engine driven units with a robust design as they are often required to work in extreme conditions. The characteristic of the output shape gave rise to the term "drooper".

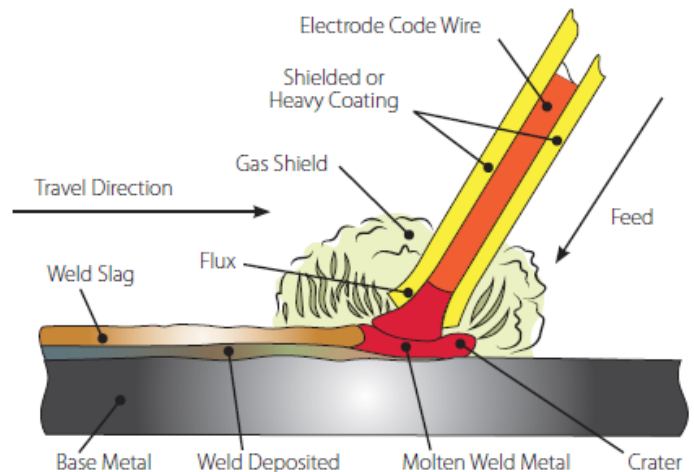

## OPERATION - MMA



Before starting any welding activity ensure that you have suitable eye protection and protective clothing. Also take the necessary steps to protect any persons within the welding area.

### The Process

The shape of the characteristic allowed the operator to control heat input and weld bead shape by electrode manipulation.

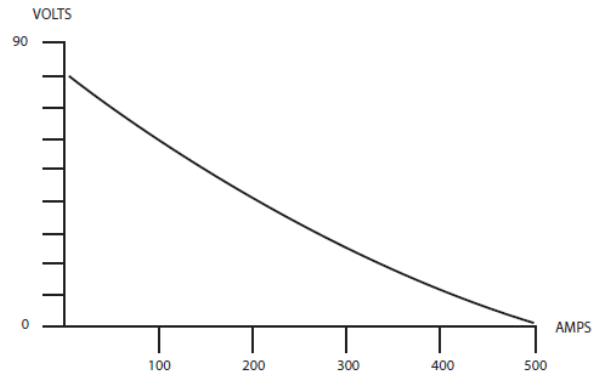

However, the TIG welder that can MMA weld had a much steeper characteristic curve which gave more problems to the welder as now the arc current remained constant despite large variations in arc voltage reducing the control by manipulation.

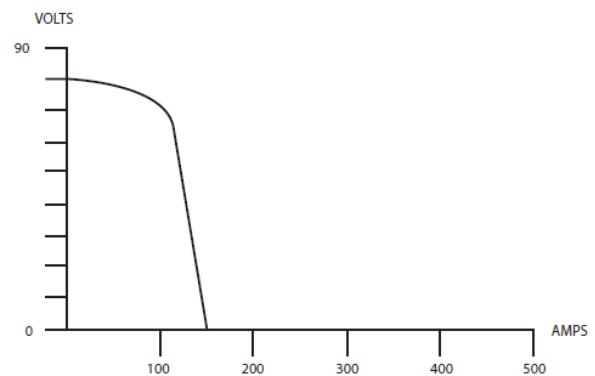

Modern inverter power supplies however can overcome these problems and provide excellent characteristic and performance as the curve can be controlled electronically for each process.

Electrode manufacture means that not all DC electrodes can operate on AC power sources but AC electrodes can operate on both AC and DC. Direct current (DC) is the most commonly used mode.

AC and DC output power sources can be used on many material types and can be obtained in wide current ranges. Inverter design has brought many advantages which are:

- Very lightweight and portable compared to their predecessors
- Very energy efficient power supplies offering energy cost savings
- Able to provide higher outputs for lower inputs
- High levels of control and performance

In general it is preferable to weld in the flat or horizontal position. When welding in position is required such as vertical or overhead it is useful to reduce the welding current compared to the horizontal position. For best results in all positions maintaining a short arc, uniform movement and travel speed in addition to consistent feeding of the electrode are required.

# OPERATION - MMA



Before starting any welding activity ensure that you have suitable eye protection and protective clothing. Also take the necessary steps to protect any persons within the welding area.

## MMA operation steps

After connecting the MMA welding leads as detailed on page 15 you will need to turn the power switch of the machine to the “ON” position.

Select MMA mode by pressing the welding mode selecting switch to the MMA position (A).

Select the MMA current mode AC or DC by pressing the welding mode selecting switch to required setting (B).

There is now welding voltage at both output terminals.

At this time, the digital display will indicate preset amperage.

If the secondary cables (welding cable and earth cable) are long, consider selecting cables with a larger cross-section to reduce the voltage drop.

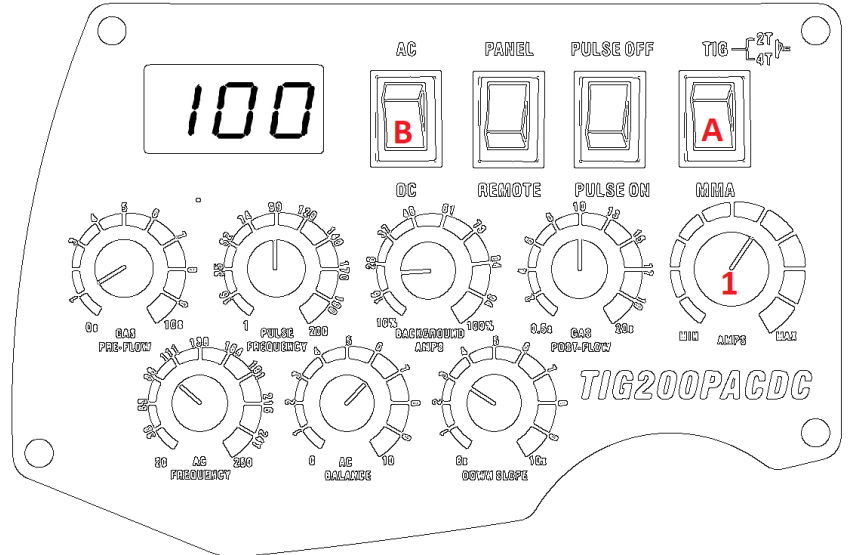

## Welding current adjustment

Output welding current is adjusted using the peak current dial (1). Rotate this adjustment control knob until the desired preset MMA welding amperage is shown on the digital display.

Welding current adjustment can be carried out during welding.

Preset the welding current according to the type and size of the electrode, clip the electrode and then welding can be carried out by short circuit arc ignition.

For welding parameters, please refer to the table below.

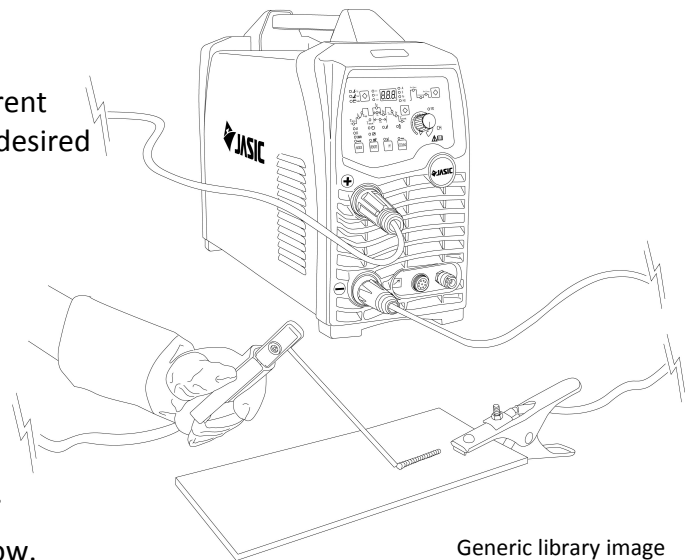

Generic library image

Electrode Diameter (mm)	Recommended Welding Current (A)	Recommended Welding Voltage (V)
1.0	20 ~ 60	20.8 ~ 22.4
1.6	44 ~ 84	21.76 ~ 23.46
2.0	60 ~ 100	22.4 ~ 24
2.5	80 ~ 120	23.2 ~ 24.8
3.2	108 ~ 148	24.32 ~ 24.92
4.0	140 ~ 180	24.6 ~ 27.2

## OPERATION - MMA



Before starting any welding activity ensure that you have suitable eye protection and protective clothing. Also take the necessary steps to protect any persons within the welding area.

### MMA welding

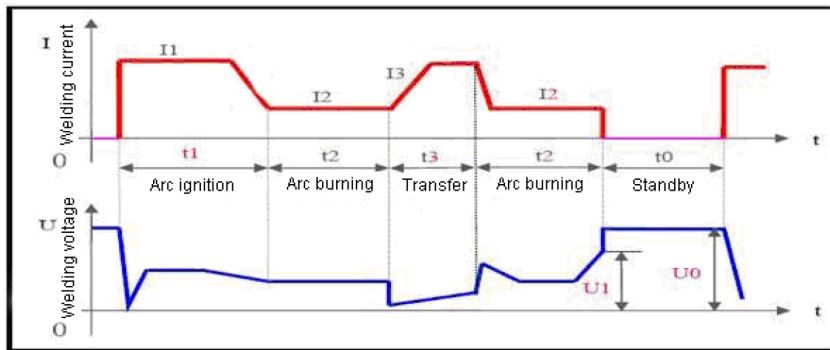

Current and Voltage Changes in DC MMA

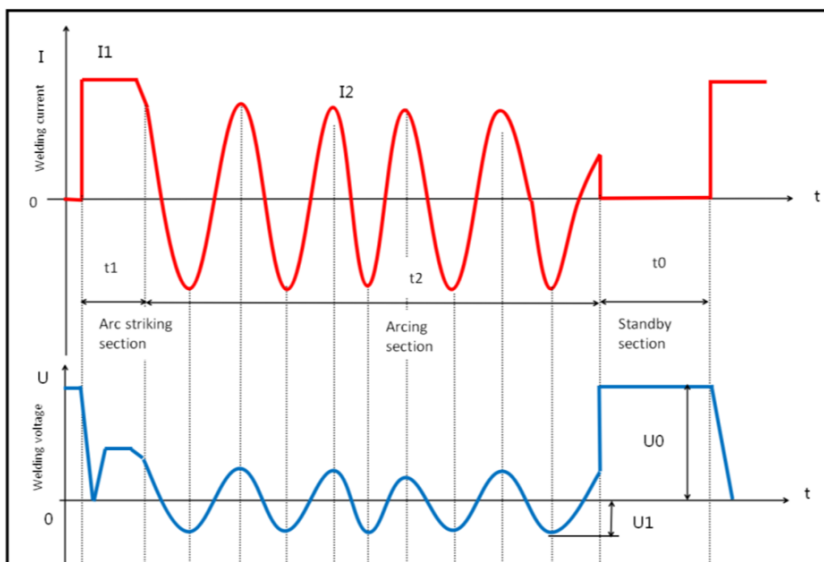

Current and Voltage Changes in AC MMA

Note:

t0 - Standby section, no welding current, output no-load voltage

t1 - Arc striking section, the length adjusted according to hot arc striking time

t2 - Arcing section

t3 - Short circuit transition section

I1 - Arc strike current

I2 - Operating current

I3 - Arc force current

U1 - Operating voltage

U0 - No-load voltage

MMA AC mode outputs - 50Hz sine wave.

Current I2 - The current of the arcing section during welding is set by the user according to the welding process requirements



## OPERATION - MMA



Before starting any welding activity ensure that you have suitable eye protection and protective clothing. Also take the necessary steps to protect any persons within the welding area.

### MMA welding

#### Arc force

Arc force refers to the slope of the current rise during a short circuit and it is set to increase the current every millisecond on this machine. After a short circuit, the current rises from the set current according to this slope. For example, when the current is set to 100A and the arc force is 10, the current value after a short circuit of 5ms is:  $100+5*10=150A$ . If the short circuit state still exists, the arc force current can rise to the permitted maximum value of 270A. If the short circuit state lasts longer than 0.8 second, the welder enters anti stick mode where the current will drop to a low value and wait for the welder to break the electrode free. The arc force value should be determined according to rod diameter, set current and process requirements. Larger arc force results in quicker transition of the droplets and less freezing of the rod into the weld pool, but too much arc force will increase the spatter. Low arc force will result in lower spatter and good weld formation but sometimes it will cause the arc to become soft or cause sticking. In particular, the arc force should be increased when welding thick rods at low current. The arc force for the JT-202A is automatically preset.

#### Electrode characteristics

During DC welding, the heat of the welding arc is different on the positive and negative electrodes. Therefore, with a DC power supply the different polarities must be taken into account. The electrode negative (DCEN) means that the welding rod is connected to the negative electrode of the power supply and the work piece is connected to the positive outlet. At this time, the work piece acquires more heat, features high temperature, deep molten pool and easy penetration and it is suitable for welding thick materials. The electrode positive (DCEP) means that the welding rod is connected to the positive outlet of the power supply and the work piece is connected to the negative outlet. At this time, the work piece acquires less heat, features low temperature, shallow molten pool and difficult penetration and it is suitable for welding thin pieces.

If AC welding equipment is used for welding, the polarities of the arcs will change alternately and instantaneously. Therefore, the two electrodes have the same heating and basically same temperatures and there is no problem in the positive connection and reverse connection.

# GUIDE TO MMA WELDING



**Before starting any welding activity ensure that you have suitable eye protection and protective clothing. Also take the necessary steps to protect any persons within the welding area.**

## Notes for the welding beginner

This section is designed to give the beginner who has not yet done any welding some information to get them going. The simplest way to start is to practice by running weld beads on a piece of scrap plate. Start by using mild steel (paint free) plate of 6.0mm thick and using 3.2mm electrodes. Clean any grease, oil and loose scale from the plate and fix firmly to your work bench so that welding can be carried out. Make sure that the work return clamp is secure and making good electrical contact with the mild steel plate, either directly or through the work table. For best results always clamp the work lead directly to the material being welding, otherwise you may experience a poor electrical circuit.

## Welding position

When welding, ensure you place yourself in a comfortable position for welding and your welding application before you begin to weld. This may be by sitting at a suitable height which often is the best way to weld, ensuring you are relaxed and not tense. A relaxed posture will ensure the welding task becomes much easier.

Please ensure you always wear suitable PPE and use suitable fume extraction when welding.

Place the work so that the direction of welding is across, rather than to or from your body.

The electrode holder lead should always be clear of any obstruction so that you can move your arm freely along as the electrode burns down. Some experienced welders prefer to have the welding lead over their shoulder, this allows greater freedom of movement and can reduce the weight from your hand. Always inspect your welding equipment, welding cables and electrode holder before each use to ensure it is not faulty or worn as you may be at risk of an electric shock.

## MMA process features and benefits

The versatility of the process and the skill level required to learn along with the basic simplicity of the equipment make the MMA welding process one of the most commonly used around the world.

The MMA process can be used to weld a wide variety of materials and is normally used in the horizontal position but can be used in vertical or overhead with the correct selection of electrode and current. In addition, it can be used to weld at long distances from the power source subject to the correct cable sizing. The self shielding effect of the electrode coating makes the process suitable for welding in external environments. It is the dominant process used in maintenance and repair industries and is used extensively in structural and fabrication work.

The process is well able to cope with less than ideal material conditions such as dirty or rusty material. Disadvantages of the process are the short welds, slag removal and stop/starts which lead to poor weld efficiency which is in the region of 25%. The weld quality is also highly dependent on the skill of the operator and many welding problems can exist.

# GUIDE TO MMA WELDING



Before starting any welding activity ensure that you have suitable eye protection and protective clothing. Also take the necessary steps to protect any persons within the welding area.

## MMA process tips and guides

### Typical welder set up

1. Electrode holder
2. Work return clamp
3. Work piece
4. Weld material covered by electrode flux or slag
5. Electrode
6. Distance from work to electrode (arc length)

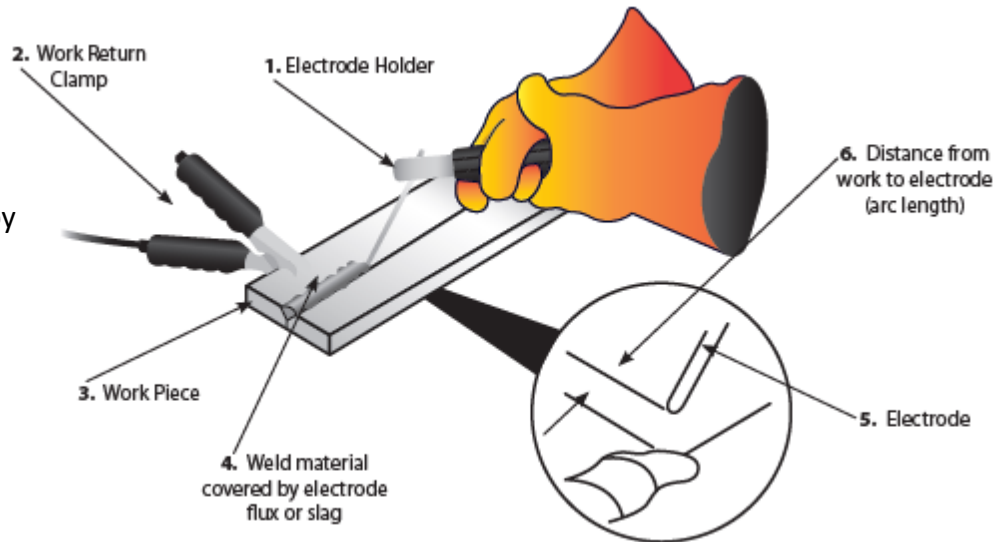

Welding current will flow in the circuit as soon as the electrode contacts the work piece. The welder should always ensure a good connection of the work clamp. The nearer the clamp is placed to the welding area the better.

When the arc is struck the distance between the end of the electrode and the work will determine the arc voltage and also affect the weld characteristic. As a guide the arc length for electrodes up to 3.2mm diameter should be around 1.6mm and for electrodes over 3.2mm it will be around 3mm.

Upon completion of the weld, the welding flux or slag will need to be removed usually with a chipping hammer and wire brush.

### Joint form in MMA

In MMA welding, the common basic joint forms are: butt joint, corner joint, lap joint & T joint.

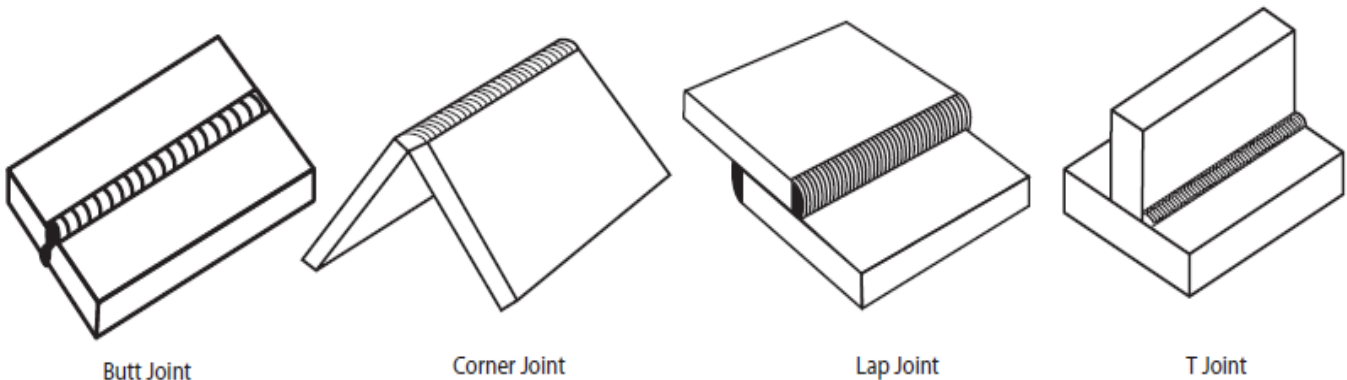

Butt Joint

Corner Joint

Lap Joint

T Joint

# GUIDE TO MMA WELDING



Before starting any welding activity ensure that you have suitable eye protection and protective clothing. Also take the necessary steps to protect any persons within the welding area.

## MMA arc striking

**Tap technique** - Lift the electrode upright and bring it down to strike the work piece. After forming a short circuit, quickly lift up about 2~4mm and arc will be ignited. This method is difficult to master.

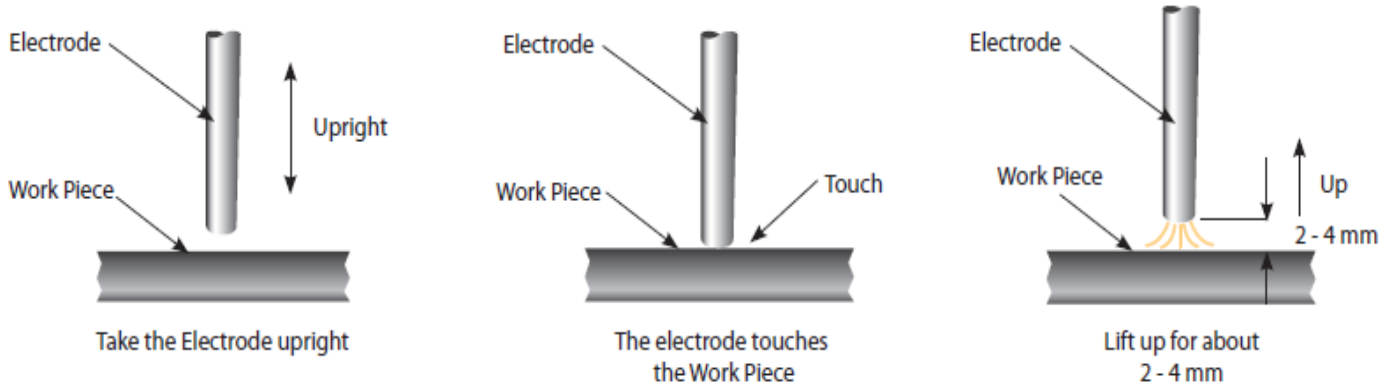

**Scratch technique** - Drag the electrode and scratch the work piece as if striking a match. Scratching the electrode may cause the arc to burn along the scratch path, so care should be taken to scratch in the weld zone. When the arc is struck adopt the correct welding position.

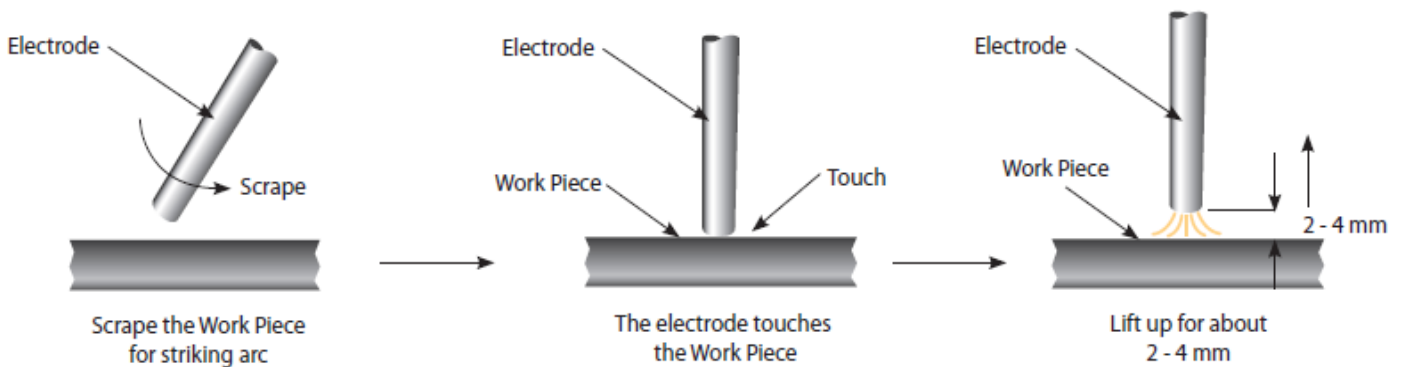

## Electrode positioning

### Horizontal or flat position

The electrode should be positioned at right angles to the plate and inclined in the direction of travel at around 10°-30°.

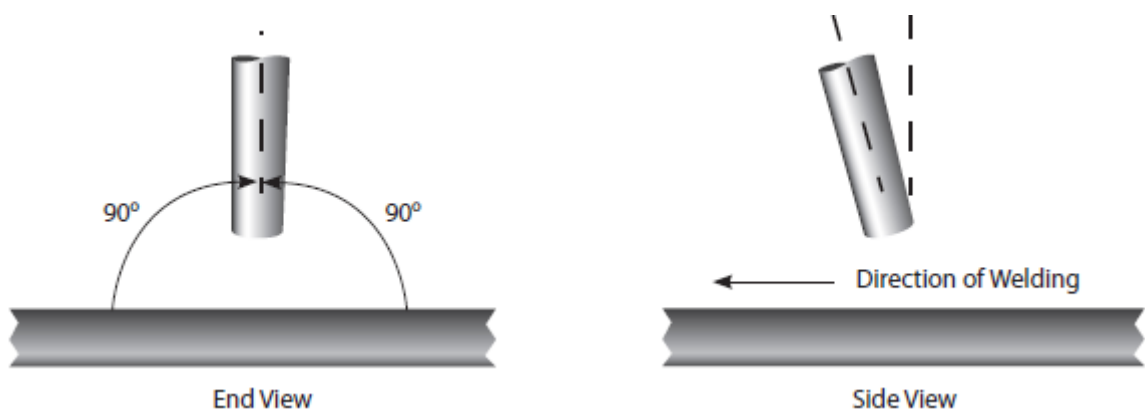

# GUIDE TO MMA WELDING



Before starting any welding activity ensure that you have suitable eye protection and protective clothing. Also take the necessary steps to protect any persons within the welding area.

## Fillet welding

The electrode should be positioned to split the angle i.e.  $45^\circ$ . Again, the electrode should be inclined in the direction of travel at around  $10^\circ$ - $30^\circ$ .

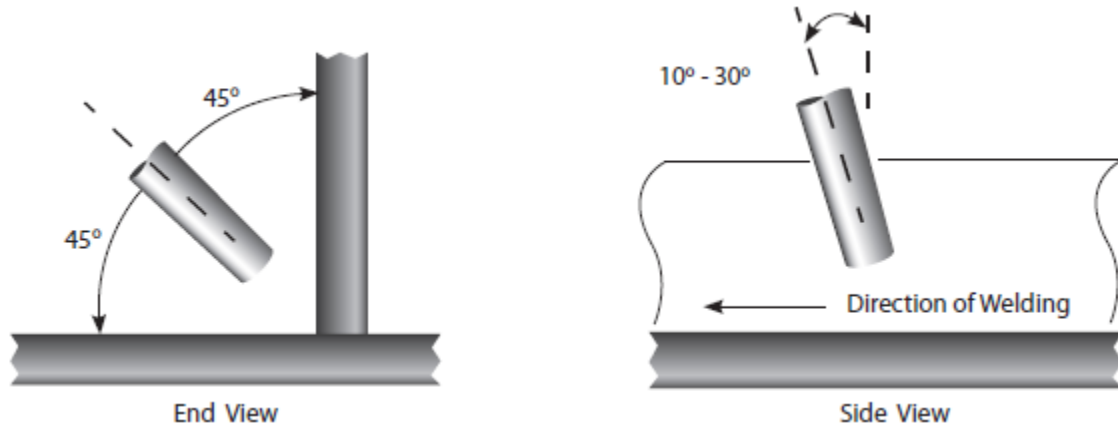

## Manipulation of electrode

In MMA welding there are three motions used at the end of electrode:

1. The electrode feeding to the molten pool along axis 3
1. The electrode swings from right and left
2. The electrode moving in the weld direction

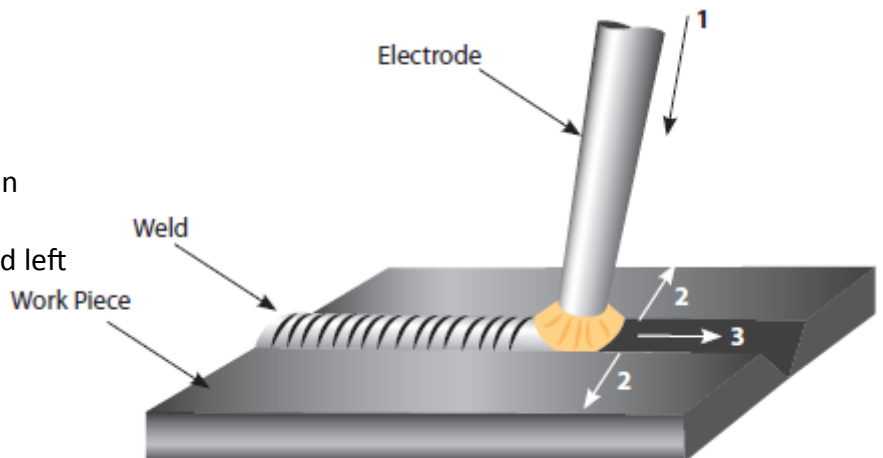

The operator can choose the manipulation of the electrode based on welding joint, welding position, electrode spec, welding current and operation skill etc.

## Weld characteristics

A good weld bead will exhibit the following characteristics:

1. Uniform weld bead
2. Good penetration into the base material
3. No overlap
4. Fine spatter level

A poor weld bead should exhibit the following characteristics:

1. Uneven and erratic bead
2. Poor penetration into the base material
3. Bad overlap
4. Excessive spatter levels
5. Weld crater

# MMA WELDING PROBLEMS



Before starting any welding activity ensure that you have suitable eye protection and protective clothing. Also take the necessary steps to protect any persons within the welding area.

## Arc welding defects and prevention methods

<u>Defect</u>	<u>Possible cause</u>	<u>Action</u>
Excessive spatter (beads of metal scattered around the weld area)	Amperage too high for the selected electrode	Reduce amperage or utilise larger diameter electrode
	Voltage too high or arc length too long	Reduce arc length or voltage
Uneven and erratic weld bead and direction	Weld bead is inconsistent and misses joint due to operator	Operator training required
Lack of penetration – The weld bead fails to create complete fusion between material to be welded, often surface appears okay but weld depth is shallow	Poor joint preparation	Joint design must allow for full access to the root of the weld
	Insufficient heat input	Material too thick Increase the amperage or increase the electrode size and amperage
	Poor weld technique	Reduce travel speed Ensure the arc is on the leading edge of the weld puddle
Porosity – Small holes or cavities on the surface or within the weld material	Work piece dirty	Remove all contaminant from the material i.e. oil, grease, rust, moisture prior to welding
	Electrode is damp	Replace or dry the electrode
	Arc length is excessive	Reduce the arc length
Excessive penetration – The weld metal is below the surface level of the material and hangs below	Heat input too high	Reduce the amperage or use a smaller electrode and lower amperage
	Poor weld technique	Use correct welding travel speed
Burning through – Holes within the material where no weld exists	Heat input too high	Use lower amperage or smaller electrode Use correct welding travel speed
Poor fusion – Failing of weld material to fuse either with the material to be welded or previous weld beads	Insufficient heat level	Increase the amperage or increase the electrode size and amperage
	Poor welding technique	Joint design must allow for full access to the root of the weld Alter welding technique to ensure penetration such as weaving, arc positioning or stringer bead technique
	Work piece dirty	Remove all contaminant from the material i.e. oil, grease, rust, moisture prior to welding

# OPERATION - DC TIG



Before starting any welding activity ensure that you have suitable eye protection and protective clothing. Also take the necessary steps to protect any persons within the welding area.

## TIG welding

Terms used: TIG – Tungsten Inert Gas, GTAW – Gas Tungsten Arc Welding.

TIG welding is an arc welding process that uses a non-consumable tungsten electrode to produce the heat for welding.

The weld area is protected from atmospheric contamination by a shielding gas (usually an inert gas such as argon or helium) and a filler rod matching the base material is normally used, though some welds, known as autogenous welds, are carried out without the need for filler wire.

TIG process can be either DC or AC modes:

DC - Direct current for welding steel, stainless steel, copper etc.

AC - Alternating current for welding aluminium and it's alloys.

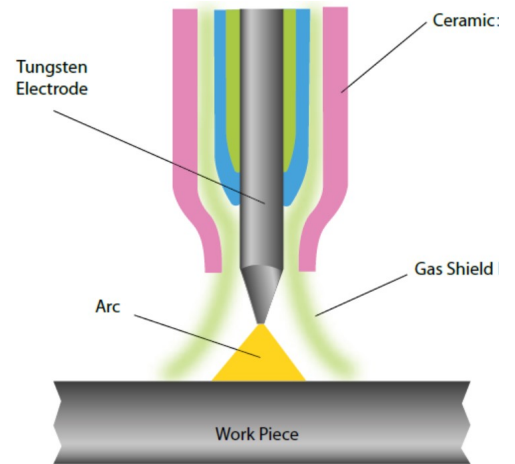

## DC TIG welding

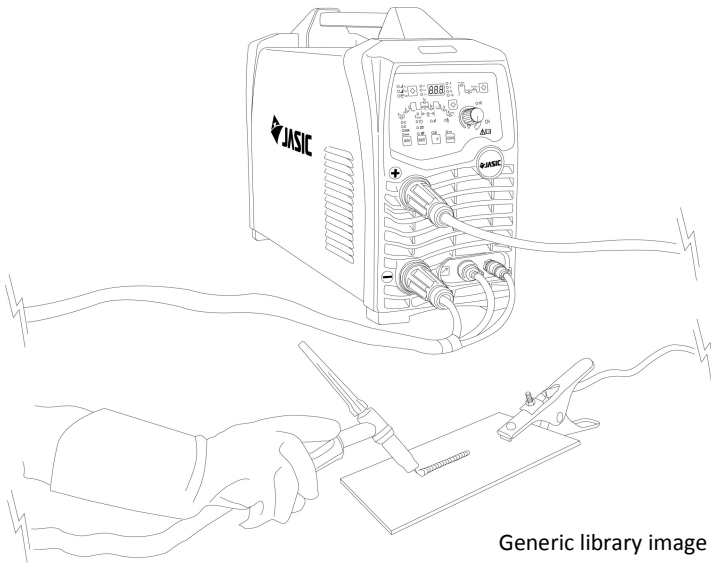

Generic library image

- Connect the TIG torch leads as shown
- Ensure a suitable inert gas supply is connected
- Turn the power switch located on the rear panel to "ON", the machine will now power up with the power LED on and the fan operating
- Select TIG mode by pressing the welding mode selection key to TIG DC with pulse depending on your welding application (see page 12)
- Open the gas valve of the cylinder and adjust the gas regulator and flow gas meter to obtain the desired flow rate. Press the torch trigger briefly, the solenoid valve will operate and gas will flow
- Adjust the welding current according to the thickness of the work piece to be welded (for

a guide to welding parameters, please refer to the table below)

- Hold the torch 2-4mm away from the work piece and then press the torch trigger. After arc is ignited, the HF discharge will cease, the current will maintain the preset value and welding can be carried out
- After releasing the torch trigger, the welding arc stops but gas continues flowing for the post flow time and welding ends
- Adjust the downslope time potentiometer to change the time according to the welding process requirements

Tungsten Size	DC – Electrode Negative
1.0mm	15 – 80A
1.6mm	70 – 150A
2.4mm	150 – 250A
3.2mm	250A – 400A
4.0mm	400A – 500A
6.0mm	750A – 1000A

This amperage guide for TIG welding tungsten sizes shown can vary depending on material, work piece thickness, welding position and joint form.

## OPERATION - DC TIG



Before starting any welding activity ensure that you have suitable eye protection and protective clothing. Also take the necessary steps to protect any persons within the welding area.

### TIG DC operation steps

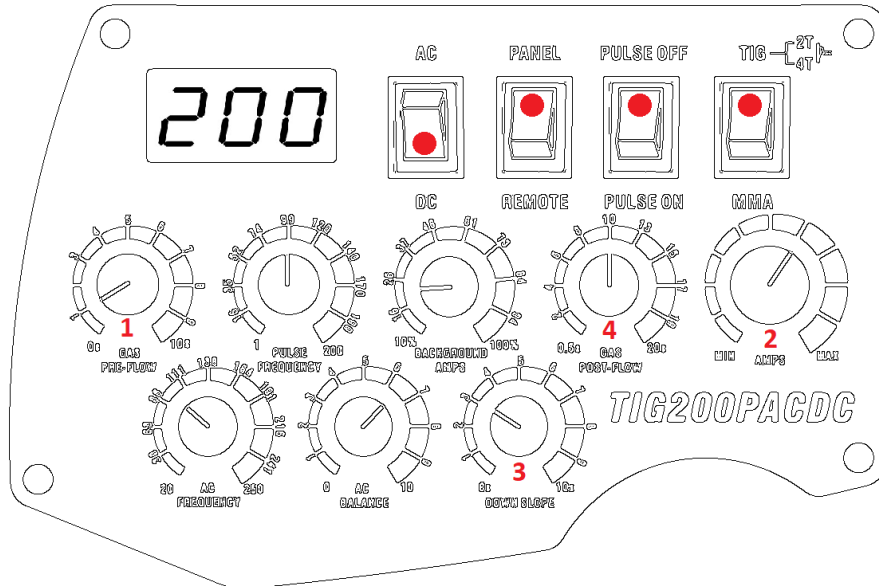

- Select TIG by pressing the TIG/MMA switch
- Select the DC by pressing the AC/DC switch
- Select panel control (unless you are using a remote current device such as a foot pedal)
- Select the standard mode (pulse off) by pressing the pulse on/off switch
- Select 2T trigger control mode by pressing the TIG/MMA switch to TIG noting in the digital meter whether 2T or 4T is shown

To select your desired gas preflow time (1), rotate the pre flow control knob to set the pre flow time. The gas pre flow adjustable time range is 0 ~ 10.0 seconds.

To set the required welding current (2), rotate the peak current control knob to set the required welding current. The DC welding current adjustable range is 10 ~ 200amps.

To set the required downslope time (3), rotate the downslope control knob to set the required time. The downslope adjustable range is 0 ~ 10 seconds.

To select your desired post gas time (4), rotate the gas after flow control knob to set the required time. The gas post flow adjustable time range is 0.5 ~ 20 seconds.

After the parameters are set appropriately, open the gas valve of the cylinder and adjust the gas regulator to the desired flow rate.

Keep the tungsten 2-4mm away from the work piece and then press the torch trigger, the solenoid valve will operate, gas will flow and HF starts.

After the arc is ignited, the HF discharge will stop and the welding current rises up to the preset value and welding can be carried out.

After releasing the torch trigger, the welding current begins to decrease automatically to the crater current value. Then the welding arc will stop but the gas keeps flowing for the duration of the post flow time and then welding ends.



## OPERATION - DC TIG



Before starting any welding activity ensure that you have suitable eye protection and protective clothing. Also take the necessary steps to protect any persons within the welding area.

### TIG DC pulse operation steps

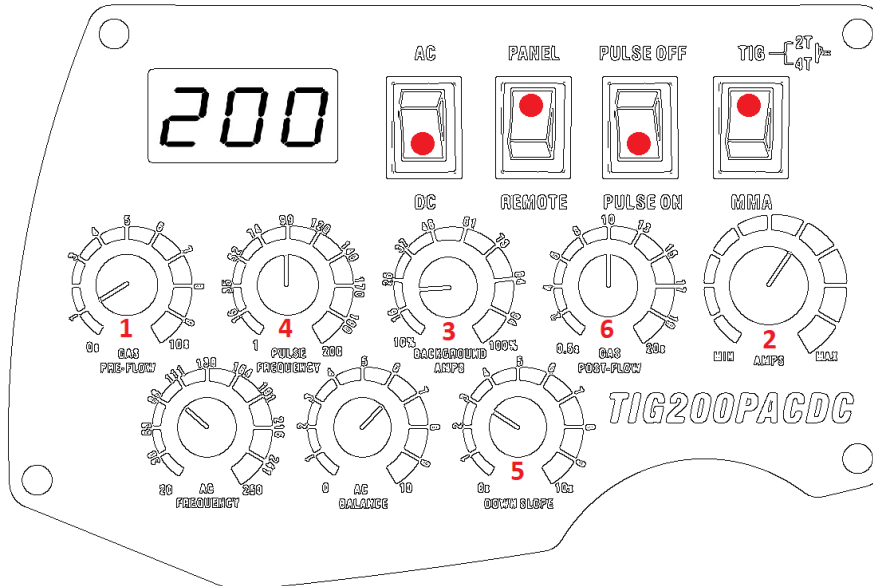

- Select TIG by pressing the TIG/MMA switch
- Select the DC by pressing the AC/DC switch
- Select panel control (unless you are using a remote current device such as a foot pedal)
- Select pulse mode by pressing the pulse ON/OFF switch
- Select 2T trigger control mode by pressing the TIG/MMA switch to TIG noting in the digital meter whether 2T or 4T is shown

To select your desired gas pre flow time (1), rotate the preflow control knob to set the pre flow time. The gas pre flow adjustable time range is 0 ~ 10.0 seconds.

To set the required welding current (2), rotate the peak current control knob to set the required welding current. The DC welding current adjustable range is 10 ~ 200amps.

To set the required background welding current (3), rotate the basic current control knob to set the required background welding current in pulse mode. The DC background current adjustable range is 10 ~ 100%.

To set the required downslope time (5), rotate the downslope control knob to set the required time. The downslope adjustable range is 0 ~ 10 seconds.

To set the required pulse frequency (4), rotate the pulse frequency control knob to set the required pulses per second. The pulse frequency adjustment range is 1 ~ 200Hz.

To select your desired post gas time (6), rotate the gas after flow control knob to set the required time. The gas post flow adjustable time range is 0.5 ~ 20 seconds.

## OPERATION - DC TIG



Before starting any welding activity ensure that you have suitable eye protection and protective clothing. Also take the necessary steps to protect any persons within the welding area.

### TIG DC pulse operation steps

After the parameters are set appropriately, open the gas valve of the cylinder and adjust the gas regulator to the desired flow rate.

Keep the tungsten 2-4mm away from the work piece and then press the torch trigger, the solenoid valve will operate, gas will flow and HF starts.

After the arc is ignited, the HF discharge will stop and the welding current rises up to the preset value and welding can be carried out.

After releasing the torch trigger, the welding current begins to decrease automatically to the crater current value. Then the welding arc will stop but the gas keeps flowing for the duration of the post flow time and then welding ends.

## OPERATION - AC TIG



Before starting any welding activity ensure that you have suitable eye protection and protective clothing. Also take the necessary steps to protect any persons within the welding area.

### TIG AC operation steps

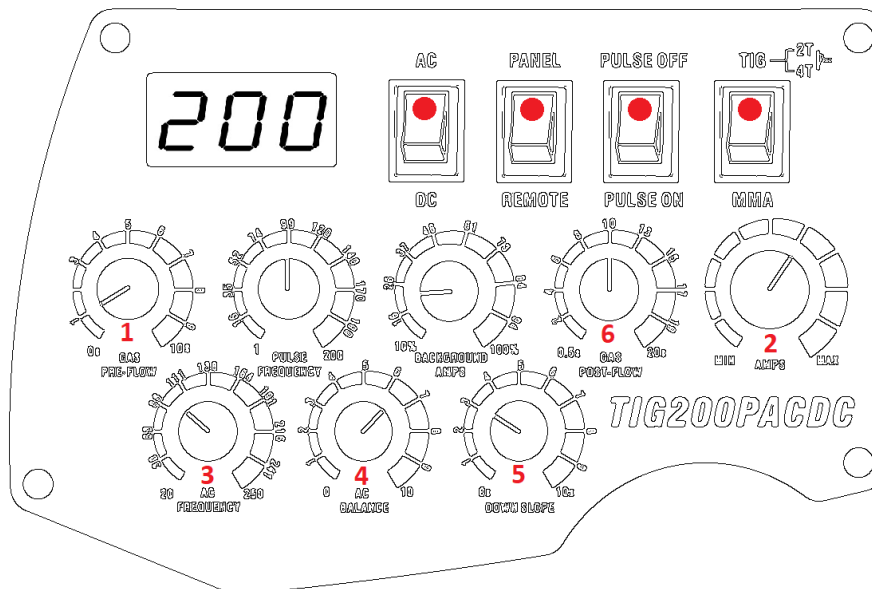

- Select TIG by pressing the TIG/MMA switch
- Select the AC by pressing the AC/DC switch
- Select panel control (unless you are using a remote current device such as a foot pedal)
- Select the standard mode (pulse off) by pressing the pulse on/off switch
- Select 2T trigger control mode by pressing the TIG/MMA switch to TIG noting in the digital meter whether 2T or 4T is shown

To select your desired gas pre flow time (1), rotate the pre flow control knob to set the pre flow time. The gas pre flow adjustable time range is 0 ~ 10.0 seconds.

To set the required welding current (2), rotate the peak current control knob to set the required welding current. The DC welding current adjustable range is 5 ~ 200amps.

To set the required downslope time (5), rotate the downslope control knob to set the required time. The downslope adjustable range is 0 ~ 10 seconds.

To select your desired post gas time (6), rotate the gas after flow control knob to set the required time. The gas post flow adjustable time range is 0 .5~ 20 seconds.

To set the required AC frequency (3), rotate the AC frequency control knob to set the required frequency. The AC frequency adjustment range is 20 ~ 250Hz.

 To select your desired AC balance (4), rotate the clean area width control knob to set the required time. The AC wave balance adjustable range is scaled 0 ~ 10 with the zero point being approximately 5.

After the parameters are set appropriately, open the gas valve of the cylinder and adjust the gas regulator to the desired flow rate.

Keep the tungsten 2-4mm away from the work piece and then press the torch trigger, the solenoid valve will operate, gas will flow and HF starts.

After the arc is ignited, HF discharge will stop and the current rises up to the preset value and welding can be carried out. After releasing the torch trigger, the current begins to decrease automatically to the crater current value. Then welding arc stops with gas keeps flowing for the post flow time and the process ends.

## OPERATION - AC TIG



Before starting any welding activity ensure that you have suitable eye protection and protective clothing. Also take the necessary steps to protect any persons within the welding area.

### TIG AC pulse operation steps

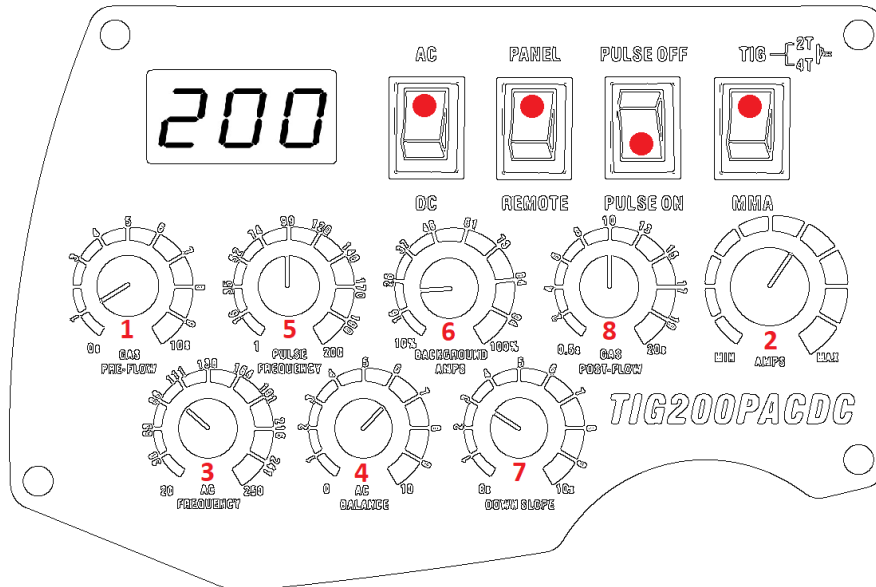

- Select TIG by pressing the TIG/MMA switch
- Select the AC by pressing the AC/DC switch
- Select panel control (unless you are using a remote current device such as a foot pedal)
- Select the pulse mode (pulse on) by pressing the pulse on/off switch
- Select 2T trigger control mode by pressing the TIG/MMA switch to TIG noting in the digital meter whether 2T or 4T is shown

To select your desired gas pre flow time (1), rotate the pre flow control knob to set the pre flow time. The gas pre flow adjustable time range is 0 ~ 10.0 seconds.

To set the required welding current (2), rotate the peak current control knob to set the required welding current. The DC welding current adjustable range is 5 ~ 200amps.

To set the required background welding current (6), rotate the basic current control knob to set the required background welding current in pulse mode. The DC background welding adjustable range is 10 ~ 100%.

To set the required pulse frequency (5), rotate the pulse frequency control knob to set the required pulses per second. The pulse frequency adjustment range is 1 ~ 200Hz.

To set the required downslope time (7), rotate the downslope control knob to set the required time. The downslope adjustable range is 0 ~ 10 seconds.

To set the required AC frequency (3), rotate the AC frequency control knob to set the required frequency. The AC frequency adjustment range is 20 ~ 250Hz.

 To select your desired AC balance (4), rotate the clean area width control knob to set the required time. The AC wave balance adjustable range scaled 0 ~ 10 with zero point being approximately 5.

## OPERATION - AC TIG



Before starting any welding activity ensure that you have suitable eye protection and protective clothing. Also take the necessary steps to protect any persons within the welding area.

### TIG AC pulse operation steps

After the parameters are set appropriately, open the gas valve of the cylinder and adjust the gas regulator to the desired flow rate.

Keep the tungsten 2-4mm away from the work piece and then press the torch trigger, the solenoid valve will operate, gas will flow and HF starts.

After the arc is ignited, the HF discharge will stop and the current rises up to the preset value and welding can be carried out.

After releasing the torch trigger, the welding current begins to decrease automatically to the crater current value. Then the welding arc will stop but the gas keeps flowing for the duration of the post flow time and then welding ends.

# TIG TORCH TRIGGER MODES



Before starting any welding activity ensure that you have suitable eye protection and protective clothing. Also take the necessary steps to protect any persons within the welding area.

## Torch trigger operation modes

Torch trigger mode options is easily accessed by pressing the 2T/4T selection switch as shown right .

To access either 2T or 4T trigger modes, you need to switch between MMA and TIG which will engage the 2T trigger mode, by switching again to MMA then back to TIG you will be in 4T trigger mode, this is noted by either 2T or 4T being shown in the digital display.

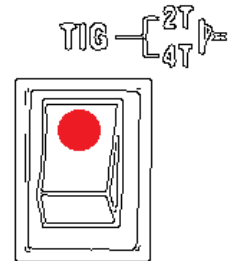

For further information on torch trigger operation modes, see below.

Mode Number	Operation	Torch trigger operation and current curve
2T	<b>Foot pedal mode:</b> <ol style="list-style-type: none"> <li>1. Push the foot pedal: Pre gas time starts, arc is then ignited and current rises to the value decided by the operator.</li> <li>2. Release foot pedal: Arc stops and post flow gas times out.</li> </ol>	
2T	<b>Standard 2T mode:</b> <ol style="list-style-type: none"> <li>1. Push the torch trigger: Pre gas time starts, arc is ignited and current rises to the preset value.</li> <li>2. Release the torch trigger: Current drops gradually, arc stops and post flow gas times out.</li> <li>3. If the torch trigger is re-operated again before arc stops, the current will rise again to status 2.</li> </ol>	
4T	<b>Standard 4T mode (latch):</b> <ol style="list-style-type: none"> <li>1. Push the torch trigger: Pre gas time starts, arc is ignited and current reaches the preset value.</li> <li>2. Release the torch trigger: Current stays at the preset value.</li> <li>3. Push the torch trigger again: Current drops to minimum arc current value.</li> <li>4. Release the torch trigger: Arc stops and post flow gas times out.</li> </ol>	

# REMOTE CONTROL SOCKET



Before starting any welding activity ensure that you have suitable eye protection and protective clothing. Also take the necessary steps to protect any persons within the welding area.

## Remote control socket

- The 9 pin remote control socket located on the front panel is used to connect a TIG torch trigger switch and/or torch mounted current adjustment dial
- This 9 pin socket is also used to connect a foot pedal or similar remote device

When fitting the 9 pin remote plug, ensure you align the keyway when inserting the plug, then rotate the threaded collar fully clockwise until finger tight.

9 Pin Remote socket configuration	
Pin No	Description
1	Potentiometer (max)
2	Potentiometer wiper
3	Potentiometer (min)
6	N/A
7	N/A
8	Torch switch
9	Torch switch

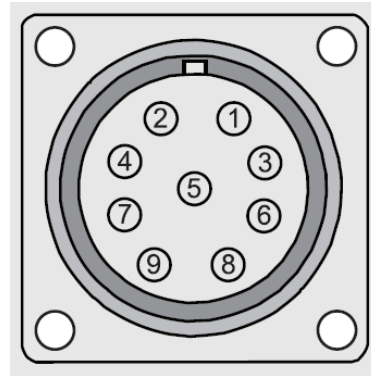

Remote socket wiring configuration

## Remote amperage control activation

Push the panel/remote switch to the remote position

## Foot control operation

Connect the foot pedal cable plug to the 9 pin remote socket.

Press the foot pedal down to start the machine output functions.

The foot control potentiometer controls the welding current up to the preset level set on the welding power source control panel.

**Please note: The maximum output current must be set on the power source control panel by the user prior to the foot control being connected.**

With the foot control connected, the panel digital ammeter will only display minimum preview amps until the foot control is depressed then it displays actual welding current when welding.

Pressing the foot pedal increases the welding current; letting up on the foot pedal decreases the welding current and releasing the pedal completely will extinguish the arc which in turn will initiate the post flow shielding gas time.

So for example, when an optional foot pedal is connected to the machine you then have the ability of controlling the slope up and down during TIG welding mode. The slope times are determined by the user pressing and depressing the foot pedal.

## Please Note:

When in remote control mode 4T is not active.

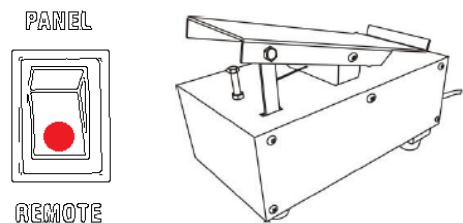

# GUIDE TO TIG WELDING



Before starting any welding activity ensure that you have suitable eye protection and protective clothing. Also take the necessary steps to protect any persons within the welding area.

## TIG torch body and components

The torch body holds the various welding consumables in place as shown and is covered by either a rigid phenolic or rubberised covering.

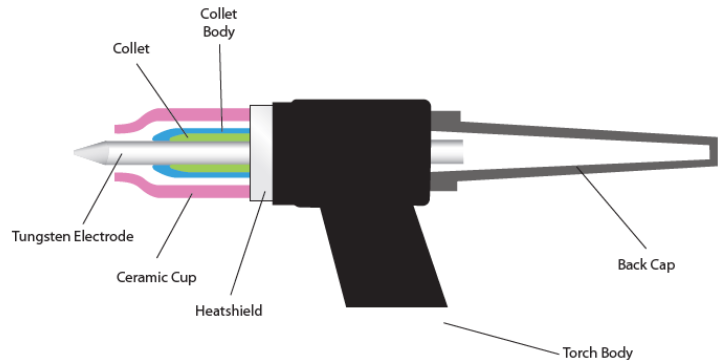

### Collet body

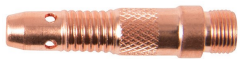

The collet body screws into the torch body. It is replaceable and is changed to accommodate the different size tungstens and their respective collets.

### Collets



The welding electrode (tungsten) is held in the torch by the collet. The collet is usually made of copper or a copper alloy. The collet's grip on the electrode is secured when the torch back cap is tightened in place. Good electrical contact between the collet and tungsten electrode is essential for good welding current transfer.

### Gas lens body

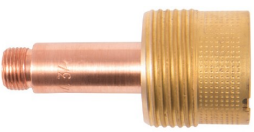

A gas lens is a device that can be used in place of the normal collet body. It screws into the torch body and is used to reduce turbulence in the flow of shield gas and produce a stiff column of undisturbed flow of shielding gas. A gas lens will allow the welder to move the nozzle further away from the joint allowing increased visibility of the arc.

A much larger diameter nozzle can be used which will produce a large blanket of shielding gas. This can be very useful in welding material like titanium. The gas lens will also enable the welder to reach joints with limited access such as inside corners.

### Ceramic cups



Gas cups are made of various types of heat resistant materials in different shapes, diameters and lengths. The cups are either screwed onto the collet body or gas lens body or in some cases pushed in place. Cups can be made of ceramic, metal, metal-jacketed ceramic, glass or other materials. The ceramic type is quite easily broken so take care when putting the torch down.

Gas cups must be large enough to provide adequate shielding gas coverage to the weld pool and surrounding area. A cup of a given size will allow only a given amount of gas to flow before the gas flow becomes disturbed due to the speed of flow. Should this condition exist the size of cup should be increased to allow the flow speed to reduce and once again establish an effective regular shield.

### Back cap

The back cap screws into the rear of the torch head and applies pressure to the back end of the collet which in turn forces up against the collet body, the resulting pressure holds the tungsten in place to ensure it does not move during the welding process.

Back caps are made from a rigid phenolic material and generally come in 3 sizes, short, medium and long.



# GUIDE TO TIG WELDING



Before starting any welding activity ensure that you have suitable eye protection and protective clothing. Also take the necessary steps to protect any persons within the welding area.

## TIG welding electrodes

TIG welding electrodes are a 'non consumable' as it is not melted into the weld pool and great care should be taken not to let the electrode contact the welding pool to avoid weld contamination. This would be referred to as tungsten inclusion and may result in weld failure.

Electrodes will often contain small quantities of metallic oxides which can offer the following benefits:

- Assist in arc starting
- Improve current carrying capacity of the electrode
- Reduce the risk of weld contamination
- Increase electrode life
- Increase arc stability

Oxides used are primarily zirconium, thorium, lanthanum or cerium. These are added usually between 1% to 4%.



Tungsten Electrode Colour Chart - DC

Welding Mode	Tungsten Type	Colour
DC or AC/DC	Ceriated 2%	Grey
DC or AC/DC	Lanthanated 1%	Black
DC or AC/DC	Lanthanated 1.5%	Gold
DC or AC/DC	Lanthanated 2%	Blue
DC	Thoriated 1%	Yellow
DC	Thoriated 2%	Red

Tungsten Electrode Current Ranges

Tungsten Electrode Size	DC Current Amp
1.0mm	30 - 60
1.6mm	60 - 115
2.4mm	100 - 165
3.2mm	135 - 200
4.0mm	190 - 280
4.8mm	250 - 340

## Tungsten electrode preparation - AC and DC

When welding at low current the electrode can be ground to a point. At a higher current a small flat on the end of the electrode is preferable as this helps with arc stability.

A balled tip is generally used with the AC welding process. To ball the end of the tungsten properly, simply apply the AC amperage recommended for a given electrode diameter and a ball will form on the end of the electrode.

## Electrode grinding

It is important when grinding the electrode to take all necessary precautions by wearing PPE such as eye protection and ensuring adequate protection against breathing in any grinding dust.

Tungsten electrodes should always be ground lengthwise (as shown) and not in a radial operation. Electrodes ground in a radial operation tend to contribute to arc wander due to the arc transfer from the grinding pattern. Always use a grinder solely for grinding electrodes to avoid contamination.

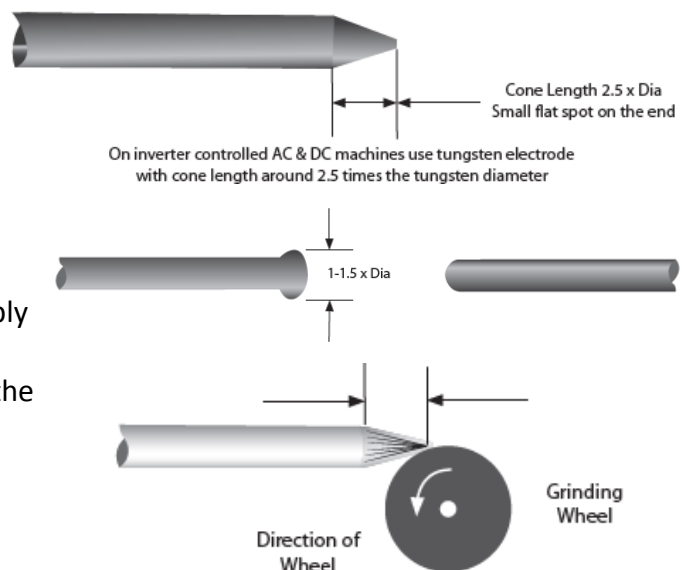

# GUIDE TO TIG WELDING



Before starting any welding activity ensure that you have suitable eye protection and protective clothing. Also take the necessary steps to protect any persons within the welding area.

## TIG welding consumables

The consumables of the TIG welding process are filler wires and shield gas.

### Filler wires

Filler wires come in many different material types and usually as cut lengths, unless some automated feeding is required where it will be in reel form. Filler wire is generally fed in by hand. Always consult the manufacturer's data and welding requirements.

Filler Wire Diameter	DC Current Range (Amps)
1.0mm	20-90
2.4mm	65-115
3.2mm	100-165
4.8mm	200-350

Filler Wire Selection Guide

### Gases

Shielding gas is required when welding to keep the weld pool free of oxygen. Whether you are welding mild steel or stainless steel the most commonly used shielding gas used in TIG welding is argon, for more specialised applications an argon helium mix or pure helium may be used.

### TIG welding - arc starting

The TIG process can use both non contact and contact methods to provide arc starting. Depending on the Jasic model, the options are indicated on a selector switch on the front control panel of the power source. The most common method of arc starting is 'HF' start. This term is often used for a variety of starting methods and covers many different types of start.

### Arc starting - scratch start

This system is where the electrode is scratched along the work piece like striking a match. This is a basic way of turning any DC stick welder into a TIG welder without much work. It is not considered suitable for high integrity welding due to the fact that the tungsten can be melted on the work piece thereby contaminating the weld.

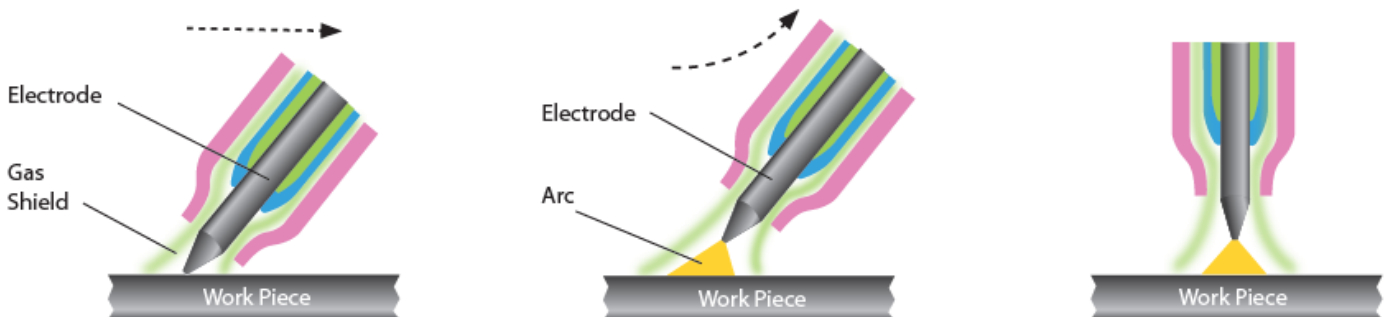

The main challenge with scratch start TIG welding is keeping your electrode clean. While a quick strike with the electrode on the metal is essential and then not lifting it more than 3mm away to create the arc will help, you also need to ensure your metal is completely clean.

# GUIDE TO TIG WELDING



Before starting any welding activity ensure that you have suitable eye protection and protective clothing. Also take the necessary steps to protect any persons within the welding area.

## Arc starting - lift TIG (lift arc)

Not to be confused with scratch start, this arc starting method allows the tungsten to be in direct contact with the work piece first but with minimal current so as not to leave a tungsten deposit when the tungsten is lifted and an arc is established.

With lift TIG start the open circuit voltage (OCV) of the welder folds back to a very low voltage output when the unit senses the tungsten has made continuity with the work piece. Once the torch is lifted the unit increases output as the tungsten leaves the surface. This creates little contamination and preserves the point on the tungsten although this is still not a 100% clean process. The tungsten still can get contaminated but lift TIG is a much better option than scratch starting for mild and stainless steel although these methods of arc starting are not a good option when welding aluminium.

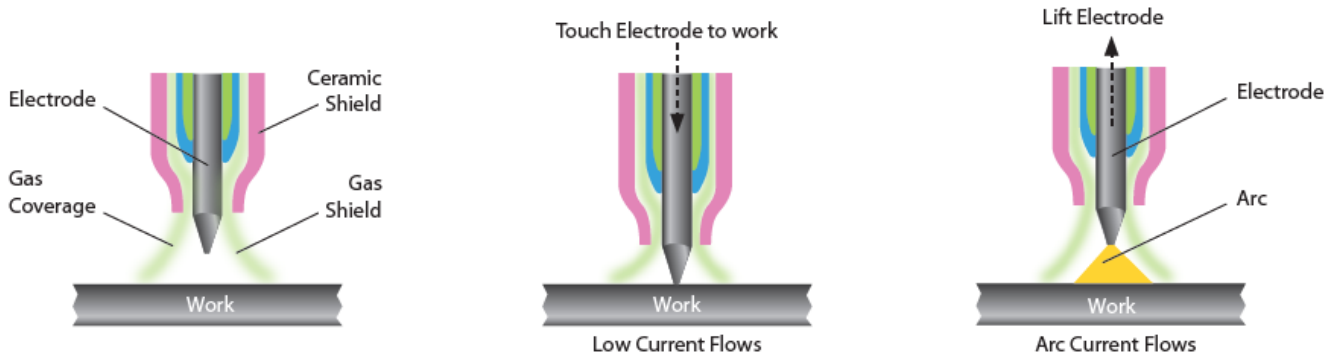

## Arc starting - HF start

Non contact high frequency (HF) start method is a high voltage and low amperage generated using a spark gap assembly and is the most popular and generally considered best TIG arc starting method. The high frequency (HF) start generates a high frequency arc that ionizes the gas bridging the gap between the tungsten point and the work piece. This touchless method creates almost no contamination unless the tungsten has been over sharpened or the start amperage is too high. It is an excellent choice for all material being welded especially aluminium although, unless you need to weld aluminium, you don't have to use HF start steel/stainless.

The HF frequency varies with the spark gap and can be around 16000 Hz to 100000 Hz depending on spark gap width so consideration should be given with this method as it can cause electrical interference to nearby electrical equipment such as computers, CNC controls and phone systems.

If the spark gap is widened, the HF can become erratic.



# GUIDE TO DC TIG WELDING



Before starting any welding activity ensure that you have suitable eye protection and protective clothing. Also take the necessary steps to protect any persons within the welding area.

## DC TIG welding

Direct current welding is when the current flows in one direction only. Compared with AC welding, the current once flowing will not go to zero until welding has ended.

The Jasic TIG series polarity should generally be set up for Direct Current - Electrode Negative (DCEN) as this method of welding can be used for a wide range of materials.

The TIG welding torch is connected to the negative output of the machine and the work return cable to the positive output.

When the arc is established the current flows in the circuit and the heat distribution in the arc is around 33% in the negative side of the arc (the welding torch) and 67% in the positive side of the arc (the work piece). This balance gives deep arc penetration of the arc into the work piece and reduces heat in the electrode.

This reduced heat in the electrode allows more current to be carried by smaller electrodes compared to other polarity connections. This method of connection is often referred to as straight polarity and is the most common connection used in DC welding.

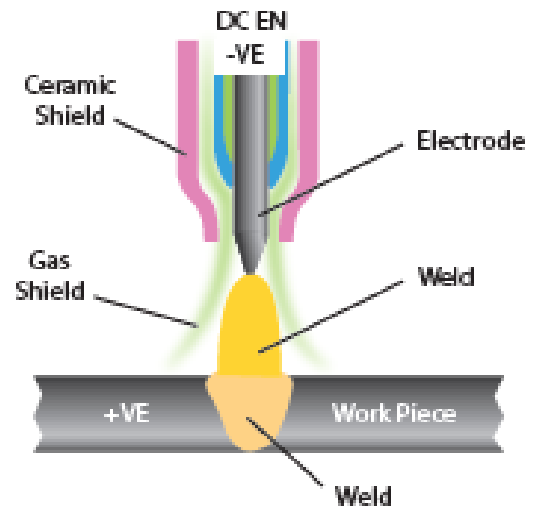

## TIG welding techniques

- Before welding (especially with mild steel) you should ensure all materials being welded are clean, as particulates can weaken the weld.
- The torch angle is best kept at 15 - 20° (from vertical) away from the direction of travel. This assists with visibility of the weld area and allows easier access for the filler material.
- The filler metal should be fed in at a low angle to help avoid touching the tungsten electrode and contaminating it.
- The TIG welding arc melts the base material and the molten puddle melts the filler rod. It is important you resist the urge to melt the filler material directly into the welding arc.
- For thinner sheet materials, a filler material may not be needed.
- Prepare the tungsten correctly, using a diamond grinding wheel will give you the best results for a sharp point (see page 36).
- For welding stainless steel, be careful of applying too much heat. If the colour is dark grey and looks dirty and heavily oxidized then too much heat has been applied, this could also cause the material to warp. Reducing the amperage and increasing travel speed may correct this problem, but you could also consider using a smaller diameter filler material, as that will require less energy to melt.

See the following page for a TIG DC welding amperage guide

# GUIDE TO DC TIG WELDING



Before starting any welding activity ensure that you have suitable eye protection and protective clothing. Also take the necessary steps to protect any persons within the welding area.

## Manual DC TIG Welding Amperage Guide- Mild Steel and Stainless Steel

Base Metal Thickness mm	Base Metal Thickness Inch	Tungsten Electrode Diameter	Output Polarity	Filler Wire Diameter (If Required)	Argon Gas Flow Rate (Litres/Min)	Joint Types	Amperage Range
1.6mm	1/16"	1.6mm	DC	1.6mm	5 - 8	Butt	50 - 80
1.6mm	1/16"	1.6mm	DC	1.6mm	5 - 8	Corner	50 - 80
1.6mm	1/16"	1.6mm	DC	1.6mm	5 - 8	Fillet	60 - 90
1.6mm	1/16"	1.6mm	DC	1.6mm	5 - 8	Lap	60 - 90
2.4mm	3/32"	1.6/2.4mm	DC	1.6/2.4mm	5 - 9	Butt	80 - 110
2.4mm	3/32"	1.6/2.4mm	DC	1.6/2.4mm	5 - 9	Corner	80 - 110
2.4mm	3/32"	1.6/2.4mm	DC	1.6/2.4mm	5 - 9	Fillet	90 - 120
2.4mm	3/32"	1.6/2.4mm	DC	1.6/2.4mm	5 - 9	Lap	90 - 120
3.2mm	1/8"	2.4mm	DC	2.4mm	5 - 10	Butt	80 - 120
3.2mm	1/8"	2.4mm	DC	2.4mm	5 - 10	Corner	90 - 120
3.2mm	1/8"	2.4mm	DC	2.4mm	5 - 10	Fillet	100 - 140
3.2mm	1/8"	2.4mm	DC	2.4mm	5 - 10	Lap	100 - 140
4.8mm	3/16"	2.4mm	DC	2.4mm	6 - 11	Butt	120 - 200
4.8mm	3/16"	2.4mm	DC	2.4mm	6 - 11	Corner	150 - 200
4.8mm	3/16"	2.4mm	DC	2.4mm	6 - 11	Fillet	170 - 220
4.8mm	3/16"	2.4mm	DC	2.4mm	6 - 11	Lap	150 - 200
6.4mm	1/4"	2.4mm	DC	3.2mm	7 - 12	Butt	225 - 300
6.4mm	1/4"	2.4mm	DC	3.2mm	7 - 12	Corner	250 - 300
6.4mm	1/4"	2.4mm	DC	3.2mm	7 - 12	Fillet	250 - 320
6.4mm	1/4"	2.4mm	DC	3.2mm	7 - 12	Lap	250 - 320
9.5mm	3/8"	3.2mm	DC	3.2mm	7 - 12	Butt	250 - 360
9.5mm	3/8"	3.2mm	DC	3.2mm	7 - 12	Corner	260 - 360
9.5mm	3/8"	3.2mm	DC	3.2mm	7 - 12	Fillet	270 - 380
9.5mm	3/8"	3.2mm	DC	3.2mm	7 - 12	Lap	230 - 380
12.7mm	1/2"	3.2/4mm	DC	3.2mm	8 - 13	Butt	300 - 400
12.7mm	1/2"	3.2/4mm	DC	3.2mm	8 - 13	Corner	320 - 420
12.7mm	1/2"	3.2/4mm	DC	3.2mm	8 - 13	Fillet	320—420
12.7mm	1/2"	3.2/4mm	DC	3.2mm	8 - 13	Lap	320 - 420

### Please Note:

- All above guide settings are approximate and will vary depending on application, prep, passes and type of welding equipment used.
- The welds would need to be tested to ensure they comply to your welding specifications.

# GUIDE TO AC TIG WELDING



Before starting any welding activity ensure that you have suitable eye protection and protective clothing. Also take the necessary steps to protect any persons within the welding area.

## AC TIG welding

Alternating current, AC welding, is when the current once flowing will not go to zero until welding has ended, compared with DC welding when the current flows in one direction only.

The Jasic TIG series polarity should generally be set up like Direct Current - Electrode Negative (DCEN) as this method of welding can be used for a wide range of materials.

The TIG welding torch is connected to the negative output of the machine and the work return cable to the positive output.

When the arc is established, the current supplied by the machine operates with either positive and negative elements of half cycles. This means current flows one way and then the other at different times so the term alternating current is used. The combination of one positive element and one negative element is termed one cycle.

The number of times a cycle is completed within one second is referred to as the frequency. In the UK the frequency of alternating current supplied by the mains network is 50 cycles per second and is denoted as 50 Hertz (Hz).

This would mean that the current changes 100 times each second. The number of cycles per second (frequency) in a standard machine is dictated by the mains frequency which in the UK is 50Hz.

It is worth noting that as frequency increases magnetic effects increase and items such as transformers become increasingly more efficient. Also increasing the frequency of the welding current stiffens the arc, improves arc stability and leads to a more controllable welding condition.

However, this is theoretical as when welding in the TIG mode there are other influences on the arc. The AC sine wave can be affected by the oxide coating of some materials which acts as a rectifier restricting the electron flow. This is known as arc rectification and its effect causes the positive half cycle to be clipped off or distorted. The effect for the weld zone is erratic arc conditions, lack of cleaning action and possible tungsten damage.

**See the following page for a TIG AC welding amperage guide**

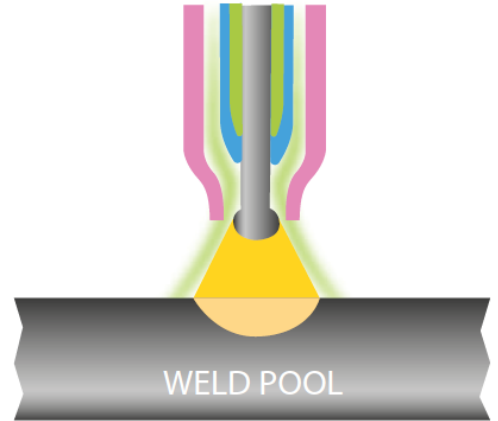

# GUIDE TO AC TIG WELDING



Before starting any welding activity ensure that you have suitable eye protection and protective clothing. Also take the necessary steps to protect any persons within the welding area.

## Manual AC TIG Welding Amperage Guide - Aluminium Material

Base Metal Thickness mm	Base Metal Thickness Inch	Tungsten Electrode Diameter	Output Polarity	Filler Wire Diameter (If Required)	Argon Gas Flow Rate (Litres/Min)	Joint Types	Amperage Range Guide
1.6mm	1/16"	1.6mm	AC	1.6mm	6 - 9	Butt	65—75
1.6mm	1/16"	1.6mm	AC	1.6mm	6 - 9	Corner	55—65
1.6mm	1/16"	1.6mm	AC	1.6mm	6 - 9	Fillet	55—75
1.6mm	1/16"	1.6mm	AC	1.6mm	6 - 9	Lap	60—70
2.4mm	3/32"	1.6/2.4mm	AC	1.6/2.4mm	8 - 10	Butt	80—110
2.4mm	3/32"	1.6/2.4mm	AC	1.6/2.4mm	8 - 10	Corner	80—110
2.4mm	3/32"	1.6/2.4mm	AC	1.6/2.4mm	8 - 10	Fillet	90—130
2.4mm	3/32"	1.6/2.4mm	AC	1.6/2.4mm	8 - 10	Lap	95—130
3.2mm	1/8"	2.4mm	AC	2.4mm	8 - 11	Butt	115—135
3.2mm	1/8"	2.4mm	AC	2.4mm	8 - 11	Corner	90—120
3.2mm	1/8"	2.4mm	AC	2.4mm	8 - 11	Fillet	100—140
3.2mm	1/8"	2.4mm	AC	2.4mm	8 - 11	Lap	105—130
4.8mm	3/16"	2.4mm	AC	2.4mm	9 - 12	Butt	125—150
4.8mm	3/16"	2.4mm	AC	2.4mm	9 - 12	Corner	130—160
4.8mm	3/16"	2.4mm	AC	2.4mm	9 - 12	Fillet	150—180
4.8mm	3/16"	2.4mm	AC	2.4mm	9 - 12	Lap	130—170
6.4mm	1/4"	2.4mm	AC	2.4mm	11 - 14	Butt	190—220
6.4mm	1/4"	2.4mm	AC	2.4mm	11 - 14	Corner	140—170
6.4mm	1/4"	2.4mm	AC	2.4mm	11 - 14	Fillet	170—190
6.4mm	1/4"	2.4mm	AC	2.4mm	11 - 14	Lap	160—180
9.5mm	3/8"	3.2mm	AC	3.2mm	12 - 15	Butt	110—260
9.5mm	3/8"	3.2mm	AC	3.2mm	12 - 15	Corner	130—260
9.5mm	3/8"	3.2mm	AC	3.2mm	12 - 15	Fillet	240—270
9.5mm	3/8"	3.2mm	AC	3.2mm	12 - 15	Lap	230—250
12.7mm	1/2"	3.2/4mm	AC	3.2mm	13 - 16	Butt	120—290
12.7mm	1/2"	3.2/4mm	AC	3.2mm	13 - 16	Corner	145—300
12.7mm	1/2"	3.2/4mm	AC	3.2mm	13 - 16	Fillet	320—350
12.7mm	1/2"	3.2/4mm	AC	3.2mm	13 - 16	Lap	280—320

### Please Note:

- All above guide settings are approximate and will vary depending on application, prep, passes and type of welding equipment used.
- The welds would need to be tested to ensure they comply to your welding specifications.

# GUIDE TO AC TIG WELDING



Before starting any welding activity ensure that you have suitable eye protection and protective clothing. Also take the necessary steps to protect any persons within the welding area.

## AC TIG welding square wave

With the electronic development of inverter power sources, the square wave machine was developed. Due to these electronic controls the cross over from positive to negative and vice versa can be made almost in an instant which leads to more effective current in each half cycle due to a longer period at maximum. The effective use of the magnetic field energy stored creates waveforms which are very near square.

The TIG 202A analog square wave machines allow us control of the positive (cleaning) and negative (penetration) half cycles.

The balance condition with equal positive and negative half cycles will give a stable weld condition. The problems that can be encountered are that once cleaning has occurred in less than the positive half cycle time then some of the positive half cycle is not productive and can also increase potential damage to the electrode due to overheating. However, this can be eliminated by the use of balance control which allows the time of the positive half cycle to be varied within the cycle time.

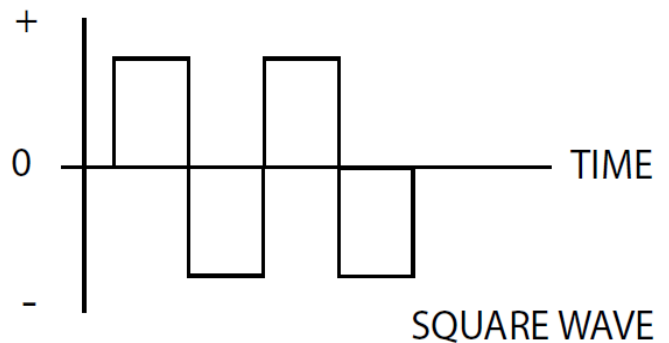

- I0 - Initial current
- I1 - Welding current
- I2 - Final current
- tu - Upslope time
- td - Downslope time
- tp - AC period
- tc - Cathode current time

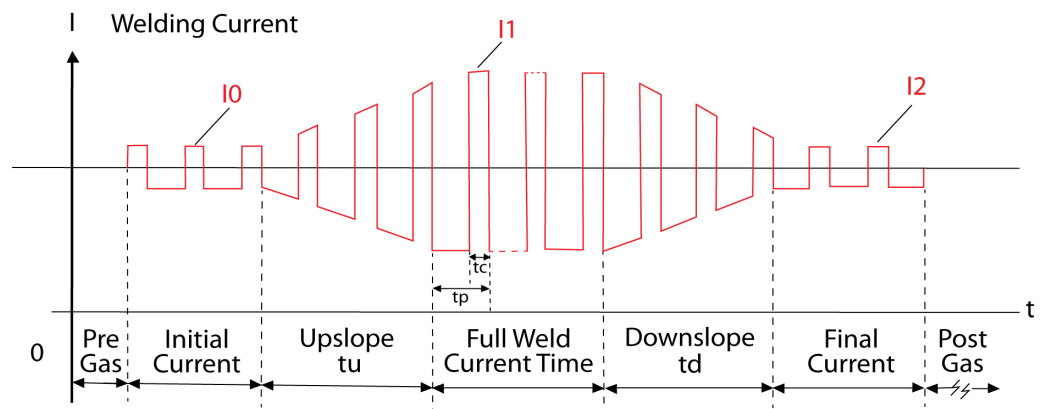

In AC square wave TIG welding, the pre flow time and post flow time are the same as in DC TIG welding. Others parameters are described below:

Initial current (I0), welding current (I1) and pilot arc current (I2).

The preset value of the three parameters is approximately the absolute average of the practical welding current and can be adjusted according to users technical requirements.

Pulse frequency ( $1/tp$ ): It can be adjusted according to users technical requirements.

Cleaning strength ( $100\% * Tc/tp$ ): Generally, in AC welding when taking the electrode as the anode, the current is called the cathode current. Its main function is to break up the oxidized layer of the work piece and the cleaning strength is the percentage cathode current holding in the AC period.

This parameter is adjustable between 20~80%. When the value is smaller the arc is concentrated and the molten pool is narrow and deep although when the value is larger, the arc is spread, the molten pool is wide and shallow.



# GUIDE TO AC TIG WELDING



Before starting any welding activity ensure that you have suitable eye protection and protective clothing. Also take the necessary steps to protect any persons within the welding area.

## AC pulsed TIG welding

Tc - Cathode current time

Tp - AC period

Tp - Pulsed peak current time

T - Pulse period

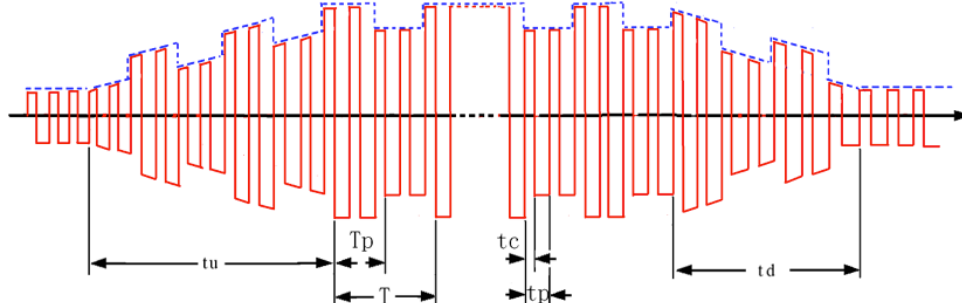

AC pulsed TIG welding is almost the same as AC square wave TIG welding and what makes them different is that in AC pulsed TIG welding the welding current varies with the pulse peak current and base current. For the AC square wave parameter selecting and setting, please refer to the corresponding contents in AC square wave TIG welding. For the pulse frequency and pulse duration ratio users may refer to the corresponding contents in DC pulsed TIG welding.

The pulse frequency ( $1/T$ ) can be adjusted between 0.5Hz and 300Hz. The pulse duration ratio ( $T_p/T$ ) can be adjusted between 10% and 90%.

## AC frequency

The normal mains frequency of equipment is 50Hz. However, the TIG 202A analog machine has an adjustable frequency output AC of 20 ~ 200Hz.

With TIG welding power supplies that have an adjustable AC frequency, lowering the AC frequency would provide a softer, less forceful wide arc which offers a wider bead with shallow penetration.

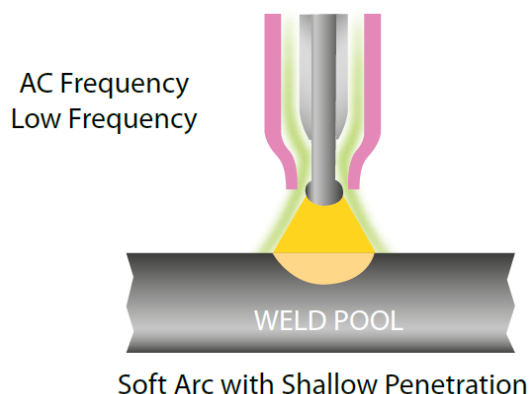

Increasing the AC frequency has the effect of concentrating the arc making it easily directional with narrower bead with deeper penetration.

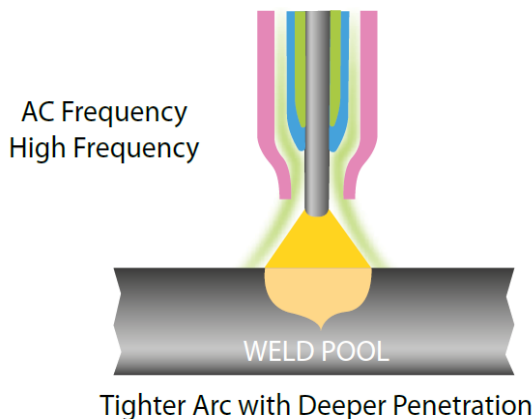

# GUIDE TO AC TIG WELDING



Before starting any welding activity ensure that you have suitable eye protection and protective clothing. Also take the necessary steps to protect any persons within the welding area.

## AC Wave balance or cleaning control

When welding materials with a refractory oxide surface such as aluminium this oxide needs to be removed to allow welding of the base material. In the AC mode the oxide is removed during the positive half of the AC wave. This control allows the user to set the amount of time between positive and negative which is represented by moving A or B in the image right.

The higher the setting the more aggressive the cleaning action but more time in the positive cycle drives more energy into the tungsten so care should be taken to avoid overheating the tungsten. AC balance zero is normally 50% positive and 50% negative.

### Please Note:

For the TIG 202A, the factor set balanced 'zero' point is represented at between 6 and 7 on the control dial and the range of balance varies between 15 ~ 85.

With the correct setting of the frequency and balance controls it is possible to use a smaller size tungsten.

## Maximum penetration

This can be achieved by placing the control to a position which will enable more time to be spent in the negative half cycle with respect to the positive half cycle. This will allow for higher current to be used with smaller electrodes as more of the heat is in the positive (work). The increase in heat also results in deeper penetration when welding at the same travel speed as the balanced condition, a reduced heat affected zone and less distortion due to the narrower arc.

### Please Note:

To obtain more penetration for the TIG 200A, the AC balance adjustment range is represented between 0 ~ 5 on the control dial.

## Maximum cleaning

This can be achieved by placing the control to a position which will enable more time to be spent in the positive half cycle with respect to the negative half cycle. This will allow for very active cleaning current to be used. It should be noted that there is an optimum cleaning time after which more cleaning will not occur and the potential of damage to the electrode is greater. The effect on the arc is to provide a wider clean weld pool with shallow penetration.

### Please Note:

To obtain more cleaning for the TIG 200A, the AC balance adjustment range is represented between 5 ~10 on the control dial.

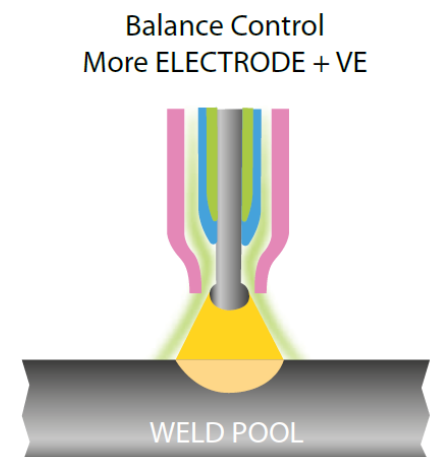
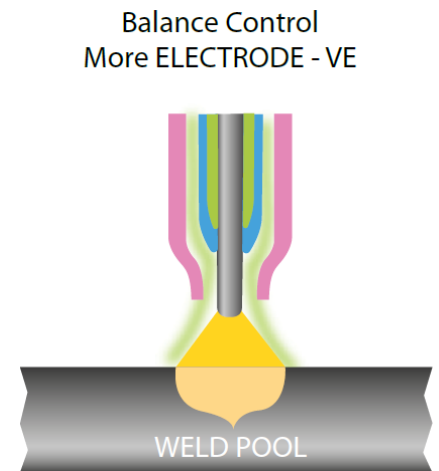
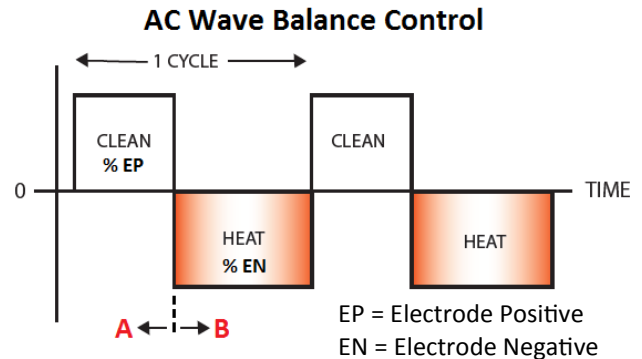

# TIG TORCH SPARE PARTS LIST



## TIG Welding Torch Air Cooled - Model TIG-79ERGO

Rating 200A DC, 150A AC @ 60% Duty Cycle EN60974-7 • 0.5mm to 4.0mm Electrodes

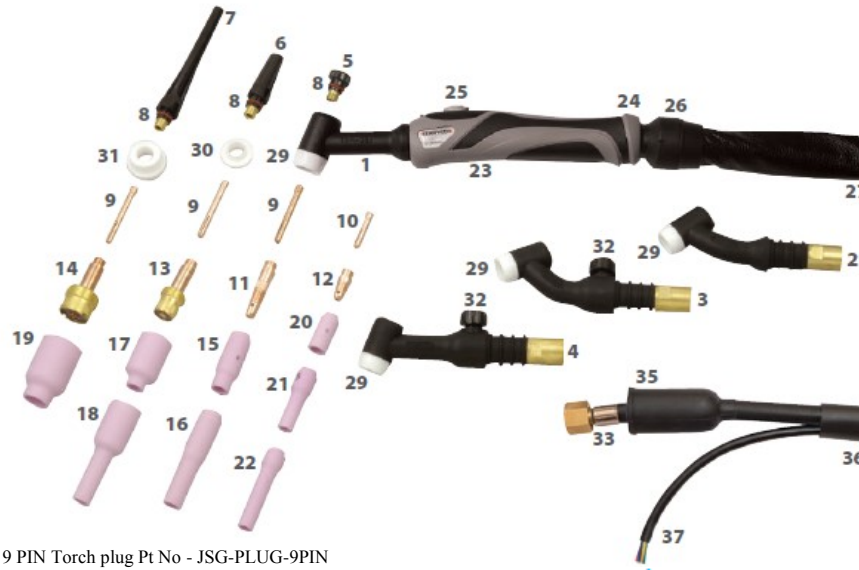

9 PIN Torch plug Pt No - JSG-PLUG-9PIN

### Consumables

Model: T26

#### Main Consumables

Code	Description	Pack Qty
1	WP26 Rigid Torch Body	1
2	WP26F Flexible Torch Body	1
3	WP26FV Flexible Torch Body c/w Argon Valve	1
4	WP26V Torch Body c/w Argon Valve	1
5	57Y04 Short Back Cap	1
6	300M Medium Back Cap	1
7	57Y02 Long Back Cap	1
8	98W18 Back Cap 'O' Ring	10

#### Collets

Code	Description	Pack Qty
9	10N21 Standard .020" (0.5mm)	5
	10N22 Standard .040" (1.0mm)	5
	10N23 Standard 1/16" (1.6mm)	5
	10N26 Standard 5/64" (2.0mm)	5
	10N24 Standard 3/32" (2.4mm)	5
	10N25 Standard 1/8" (3.2mm)	5
	54N20 Standard 5/32" (4.0mm)	5
10	10N21S Stubby .020" (0.5mm)	5
	10N22S Stubby .040" (1.0mm)	5
	10N23S Stubby 1/16" (1.6mm)	5
	10N24S Stubby 3/32" (2.4mm)	5
	10N25S Stubby 1/8" (3.2mm)	5

#### Collet Bodies

Code	Description	Pack Qty
11	10N29 Standard .020" (0.5mm)	5
	10N30 Standard .040" (1.0mm)	5
	10N31 Standard 1/16" (1.6mm)	5
	10N31M Standard 5/64" (2.0mm)	5
	10N32 Standard 3/32" (2.4mm)	5
	10N28 Standard 1/8" (3.2mm)	5
	406488 Standard 5/32" (4.0mm)	5
12	17CB20 Stubby .020" - 1/8" (0.5 - 3.2mm)	5

#### Gas Lens Bodies

Code	Description	Pack Qty
13	45V29 Standard .020" (0.5mm)	1
	45V24 Standard .040" (1.0mm)	1
	45V25 Standard 1/16" (1.6mm)	1
	45V25M Standard 5/64" (2.0mm)	1
	45V26 Standard 3/32" (2.4mm)	1
	45V27 Standard 1/8" (3.2mm)	1
	45V28 Standard 5/32" (4.0mm)	1
14	45V0204 Large Dia .020"-.040" (0.5 - 1.0mm)	1
	45V116 Large Dia 1/16" (1.6mm)	1
	45V64 Large Dia 3/32" (2.4mm)	1
	995795 Large Dia 1/8" (3.2mm)	1
	45V63 Large Dia 5/32" (4.0mm)	1

#### Ceramic Cups

Code	Description	Pack Qty
15	10N50 Standard Cup 1/4" Bore	10
	10N49 Standard Cup 5/16" Bore	10
	10N48 Standard Cup 3/8" Bore	10
	10N47 Standard Cup 7/16" Bore	10
	10N46 Standard Cup 1/2" Bore	10
	10N45 Standard Cup 5/8" Bore	10
	10N44 Standard Cup 3/4" Bore	10

#### Ceramic Cups (continued)

Code	Description	Pack Qty
16	10N50L Long Cup 1/4" Bore	10
	10N49L Long Cup 5/16" Bore	10
	10N48L Long Cup 3/8" Bore	10
	10N47L Long Cup 7/16" Bore	10

#### Gas Lens Cups

Code	Description	Pack Qty
17	54N18 Standard Cup 1/4" Bore	10
	54N17 Standard Cup 5/16" Bore	10
	54N16 Standard Cup 3/8" Bore	10
	54N15 Standard Cup 7/16" Bore	10
	54N14 Standard Cup 1/2" Bore	10
	54N19 Standard Cup 11/16" Bore	10
18	54N17L Long Cup 5/16" Bore	10
	54N16L Long Cup 3/8" Bore	10
	54N15L Long Cup 7/16" Bore	10
	54N14L Long Cup 1/2" Bore	10
19	57N75 Large Dia Cup 3/8" Bore	5
	57N74 Large Dia Cup 1/2" Bore	5
	53N88 Large Dia Cup 5/8" Bore	5
	53N87 Large Dia Cup 3/4" Bore	5

#### Ceramic Cups for use with item 12

Code	Description	Pack Qty
20	13N08 Standard Cup 1/4" Bore	10
	13N09 Standard Cup 5/16" Bore	10
	13N10 Standard Cup 3/8" Bore	10
	13N11 Standard Cup 7/16" Bore	10
	13N12 Standard Cup 1/2" Bore	10
	13N13 Standard Cup 5/8" Bore	10
21	796F70 Long Cup 3/16" Bore	10
	796F71 Long Cup 1/4" Bore	10
	796F72 Long Cup 5/16" Bore	10
	796F73 Long Cup 3/8" Bore	10
22	796F74 X - Long Cup 3/16" Bore	10
	796F75 X - Long Cup 1/4" Bore	10
	796F76 X - Long Cup 5/16" Bore	10
	796F77 X - Long Cup 3/8" Bore	10

#### Secondary Consumables

Code	Description	Pack Qty
23	SP9110 LH & RH Handle Shell	1
	SP9111 Handle Screw	1
25	SP9120 Single Button Switch	1
	SP9121 2 Button Switch	1
	SP9122 5K Potentiometer Switch	1
	SP9123 10K Potentiometer Switch	1
	SP9128 47K Potentiometer Switch	1
	SP9129 4 Button Switch	1
26	SP9114 Handle Ball Joint	1
27	SP9117 Leather Cover 800mm	1
28	SP9119 Cable Cover Joint (not illustrated)	1
29	18CG Standard Heat Shield	1
30	54N01 Gas Lens Heat Shield	1
31	54N63 Large Gas Lens Insulator	1
32	VS-1 Valve Stem WP26V & WP26FV	1
33	46V28 Mono Power Cable Assy 12.5ft - 3/8" Bsp	1
	46V30 Mono Power Cable Assy 25ft - 3/8" Bsp	1
34	46V28-2D 2 Piece Power Cable Assy 12.5ft - Dinse / 3/8" Bsp	1
	46V30-2D 2 Piece Power Cable Assy 25ft - Dinse / 3/8" Bsp	1
35	0315071 Insulation Boot	5
36	6091 Neoprene Protective Cover	1m
37	SP9126 4m Switch Cable c/w 5 Pin Receptacle	1
	SP9127 8m Switch Cable c/w 5 Pin Receptacle	1

PLEASE NOTE: Check the torch supplied with your package to ensure it matches the above details

# TIG WELDING PROBLEMS



Before starting any welding activity ensure that you have suitable eye protection and protective clothing. Also take the necessary steps to protect any persons within the welding area.

## TIG welding defects and prevention methods

<u>Defect</u>	<u>Possible cause</u>	<u>Action</u>
Excessive tungsten use	Set up for DCEP	Change to DCEN
	Insufficient shield gas flow	Check for gas restriction and correct flow rates. Check for drafts in the weld area
	Electrode size too small	Select correct size
	Electrode contamination during cooling time	Extend post flow gas time
Porosity/weld contamination	Loose torch or hose fitting	Check and tighten all fittings
	Inadequate shield gas flow	Adjust flow rate - normally 8-12L/m
	Incorrect shield gas	Use correct shield gas
	Gas hose damaged	Check and repair any damaged hoses
	Base material contaminated	Clean material properly
	Incorrect filler material	Check correct filler wire for grade of use
No operation when torch switch is operated	Torch switch or cable faulty	Check the torch switch continuity and repair or replace as required
	ON/OFF switch turned off	Check position of ON/OFF switch
	Mains fuses blown	Check fuses and replace as required
	Fault inside the machine	Call for a repair technician
Low output current	Loose or defective work clamp	Tighten/replace clamp
	Loose cable plug	Check and tighten all plugs
	Power source faulty	Call a repair technician
High frequency will not strike the arc	Weld/power cable open circuit	Check all cables and connections for continuity, especially the torch cables
	No shield gas flowing	Check cylinder contents, regulator and valves, also check the power source
Unstable arc when welding in DC	Tungsten contaminated	Break off contaminated end and regrind the tungsten
	Arc length incorrect	Arc length should be between 3-6mm
	Material contaminated	Clean all base and filler material
	Electrode connected to the wrong polarity	Reconnect to correct polarity
Arc is difficult to start	Incorrect tungsten type	Check and fit correct tungsten
	Incorrect shield gas	Use argon shield gas

# TIG WELDING PROBLEMS



Before starting any welding activity ensure that you have suitable eye protection and protective clothing. Also take the necessary steps to protect any persons within the welding area.

## TIG welding defects and prevention methods

<u>Defect</u>	<u>Possible cause</u>	<u>Action</u>
Excessive bead build up, poor penetration or poor fusion at the edges of the weld	Weld current too low	Increase the welding amperage Poor material preparation
Weld bead flat and too wide or undercut at the weld edge or burning through	Weld current too high	Decrease the welding amperage
Weld bead too small or insufficient penetration	Welding travel speed too fast	Reduce your welding travel speed
Weld bead too wide or excessive bead build up	Welding travel speed too slow	Increase your welding travel speed
Uneven leg length in fillet joint	Wrong placement of filler rod	Re-position filler rod
Tungsten melts or oxidises when welding arc is made	TIG torch lead connected to + Little or no gas flow to weld pool  Gas cylinder or hoses contain impurities The tungsten is too small for the weld current TIG/MMA selector set to MMA	Connect to - polarity Check gas apparatus as well as torch and hoses for breaks or restrictions Change gas cylinder and blow out torch and gas hoses Increase the size of the tungsten  Ensure you have the power source set to TIG function

## MAINTENANCE



The following operation requires sufficient professional knowledge on electric aspects and comprehensive safety knowledge. Make sure the input cable of the machine is disconnected from the electricity supply and wait for 5 minutes before removing the machine covers.

In order to guarantee that the arc welding machine works efficiently and in safety, it must be maintained regularly. Operators should understand the maintenance methods and means of arc welding machine operation. This guide should enable customers to carry out simple examination and safeguarding by themselves, and to reduce the fault rate and repair times of the arc welding machine, so as to lengthen the service life of your TIG welding machine.

### Period

### Maintenance item

<b>Daily examination</b>	<ul style="list-style-type: none"> <li>• Check the condition of the machine, mains cables, welding cables and connections.</li> <li>• Check for any warnings LEDs and machine operation.</li> </ul>
<b>Monthly examination</b>	<ul style="list-style-type: none"> <li>• Disconnect from the mains supply and wait for at least 5 minutes before removing the cover.</li> <li>• Check internal connections and tighten if required.</li> <li>• Clean the inside of the machine with a soft brush and vacuum cleaner.</li> <li>• Take care not to remove any cables or cause damage to components.</li> <li>• Ensure that ventilation grills are clear.</li> <li>• Carefully replace the covers and test the unit.</li> </ul> <p><b>This work should be carried out by a suitably qualified competent person.</b></p>
<b>Yearly examination</b>	<ul style="list-style-type: none"> <li>• Carry out an annual service to include a safety check in accordance with the manufacturers standard (EN 60974-1).</li> </ul> <p><b>This work should be carried out by a suitably qualified competent person.</b></p>

⇒ **Ensure the power is disconnected before working on the machine.**

⇒ **Always wait 5 minutes after power switch off before opening the case.**

## SERVICE SCHEDULE RECORD

Date	Type of service and work carried out	Serviced by	Due date for next check

## TROUBLESHOOTING



The following operation requires sufficient professional knowledge on electric aspects and comprehensive safety knowledge. Make sure the input cable of the machine is disconnected from the electricity supply and wait for 5 minutes before removing the machine covers.

Before arc welding machines are dispatched from the factory, they have already been checked thoroughly. The machine should not be tampered with or altered. Maintenance must be carried out carefully. If any wire becomes loose or is misplaced, it may potentially be dangerous to the user!

Only professional maintenance personnel should repair the machine!

Ensure the power is disconnected before working on the machine. Always wait 5 minutes after power switch off before removing the panels.

Description of fault	Possible cause
The power LED is OFF and the fan is not functioning	The primary supply voltage has not been switched ON or input fuse has blown
	The welding power source input switch is switched OFF
	Loose connections internally
The fault LED is ON and the fan is running	The machine is under 'over-heating' protection status and will recover automatically after the welding machine has cooled down Check incoming mains supply to ensure it is within +/- 15% of the machines designed incoming voltage
No high frequency is produced	Process selection switch is set to manual metal arc (MMA)
	Torch trigger switch lead is disconnected or switch/lead is faulty
	High frequency spark gap too wide or short circuited
Welding current reduces when welding	Poor work lead connection to the work piece
TIG electrode melts when arc is struck	TIG torch is connected to the (+) VE terminal
No gas flow when the TIG torch trigger switch is depressed	Empty gas cylinder
	Gas regulator is turned off
	Gas hose is blocked or cut
	Torch trigger switch lead is disconnected or switch/lead is faulty
Difficult to ignite the arc	The arc ignition current is too low or the arc ignition time is too short
The electrode holder becomes very hot	The rated current of the electrode holder is smaller than its actual working current, replace it with a higher rated current capacity
Excessive spatter in MMA welding	The output polarity connection is incorrect, exchange the polarity
Other malfunction	Contact your supplier

⇒ **Ensure the power is disconnected before working on the machine.**

⇒ **Always wait 5 minutes after power switch off before opening the case.**

## WEEE disposal

The equipment is manufactured with materials which do not contain any toxic or poisonous materials dangerous to the operator.

When the equipment is scrapped, it should be dismantled separating components according to the type of materials.

Do not dispose of the equipment with normal waste. The European Directive 2002/96/EC and United Kingdom's Directive The Waste Electrical and Electronic Equipment (WEEE) regulations 2013 states that electrical equipment that has reached its end of life must be collected separately and returned to an environmentally compatible recycling facility.

Jasic has a relevant recycling system which is compliant and registered in the UK with the environment agency. Our registration reference is WEEMM3813AA.

In order to comply with WEEE regulations outside the UK you should contact your supplier.

## RoHS Compliance Declaration

We herewith confirm, that the above mentioned product does not contain any of the restricted substances as listed in EU Directive 2011/65/EU and the UK directive ROHS Regulations 2012 in concentrations above the limits as specified therein.

## UKCA Declaration of Conformity

The manufacturer, or its legal representative Wilkinson Star Limited, declares that the equipment described below is designed and produced according to following UK legislation:

- Electrical equipment safety 2016
- Electromagnetic compatibility (EMC) regulations 2016
- The restrictions of the use of certain hazardous substances in electrical and electronic equipment regulations 2012

And inspected according to following designated standards:

- EN 60 974-1:2018+A1:2019
- EN 60 974-10:2014+A1:2015

Any alteration or change to these machines by any unauthorized person makes this declaration invalid.

**Model:**

**JT-202A**

**Authorised Representative:**

Wilkinson Star Limited  
Shield Drive  
Wardley Industrial Estate  
Worsley  
Manchester  
M28 2WD

### **Disclaimer:**

Please note that this confirmation is given to the best of our present knowledge and belief. Nothing herein represents and/or may be interpreted as warranty within the meaning of the applicable warranty law.



# EC Declaration of Conformity

## EC DECLARATION OF CONFORMITY

The manufacturer, or its legal representative **Wilkinson Star Limited**, declares that the equipment described below is designed and produced according to following EU Directives:

- Low Voltage Directive (LVD), No.: 2014/35/EU
- Electromagnetic compatibility (EMC) Directive, No.: 2014/30/EU

And inspected according to following

EU - Norms:

- EN 60 974-1:2012
- EN 60 974-10:2014+A1

Any alteration or change to these machines by any unauthorized person makes this Declaration invalid.

### Wilkinson Star model

JT-202A

JT-202D

### Jasic Model

TIG 200P ACDC Analogue (E20102)

TIG 200P ACDC Digital (E20103)

### Authorised Representative

Wilkinson Star Limited  
Shield Drive, Wardley Industrial Estate,  
Worsley, Manchester M28 2WD  
Tel 0161 793 8127

### Manufacturer

Shenzhen Jasic Technology Co LTD  
No3 Qinglan, 1st Road  
Pingshan District  
Shenzhen, China

Signature



Dr John A Wilkinson OBE

Position Chairman

Signature



Shenzhen Jasic Technology Co LTD

Position

Date



Date

2021/7/6



## STATEMENT OF WARRANTY

All new JASIC welders, plasma cutters and multi-process units sold through our partner Wilkinson Star Limited within the United Kingdom and Ireland shall be warranted to the original owner, non transferable, against failure due to defective materials or production. The warranty period is 5 years following the date of purchase. We recommend you register your product within 28 days of purchase. The original invoice is documentation for the standard warranty period. The warranty period is based on a single shift pattern.

Defective units shall be repaired or replaced by the company at our workshop. The company may opt to refund the purchase price (less any costs and depreciation due to use and wear). The company reserves the right to alter the warranty conditions at any time with effect for the future.

A prerequisite for the full warranty is that products are operated in accordance with the operating instructions supplied, observing the relevant installation and any legal requirements recommendations and guidelines and carrying out the maintenance instructions shown in the operator manual. This should be carried out by a suitably qualified competent person.

In the unlikely event of a problem, this should be reported to Jasic technical support team to review the claim.

The customer has no claim to loan or replacement products whilst repairs are being performed.

The following falls outside the scope of the warranty:

- Defects due to natural wear and tear
- Failure to observe the operating and maintenance instructions
- Connection to an incorrect or faulty mains supply
- Overloading during use
- Any modifications that are made to the product without the prior written consent
- Software errors due incorrect operation
- Any repairs that are carried out using non-approved spare parts
- Any transport or storage damage
- Direct or indirect damage as well as any loss of earnings are not covered under the warranty
- External damage such as fire or damage due to natural causes e.g. flooding

**NOTE:** Under the terms of the warranty, welding torches, their consumable parts, wire feed unit drive rolls and guide tubes, work return cables and clamps, electrode holders, connection and extension cables, mains and control leads, plugs, wheels, coolant etc. are covered with a 3 month warranty.

Jasic shall in no event be responsible for any third party expenses or expenses/costs or any indirect or consequential expenses/costs.

Jasic will submit an invoice for any repair work performed outside the scope of the warranty. A quotation for any non warranty will be raised prior to any repairs being carried out.

The decision about repair or replacement of the defective part(s) is made by Jasic. The replaced part(s) remain(s) Jasic property.

Warranty extends only to the machine, its accessories and parts contained inside. No other warranty is expressed or implied. No warranty is expressed or implied in regards to the fitness of the product for any particular application or use.

For further information on Jasic product warranty terms and product warranty registration please visit:

[www.jasic-warranty.co.uk/terms](http://www.jasic-warranty.co.uk/terms)

[www.jasic-warranty.co.uk](http://www.jasic-warranty.co.uk)

## OPTIONS AND ACCESSORIES

Part Number	Description
---	<b>TIG torch options for JT-202A air cooled package</b>
TIG-79ERGO	WP26 TIG Torch 12.5ft c/w Dinse Adaptor + Jasic Plug
TIG-79ERGO-FLEXI	WP26F TIG Torch 12.5ft c/w Dinse Adaptor + Jasic Plug
TIG-79ERGO-8M	WP26 TIG Torch 25ft c/w Dinse Adaptor + Jasic Plug
TIG-79ERGO-8MFLEXI	WP26F TIG Torch 12.5ft c/w Dinse Adaptor + Jasic Plug
TIG-83-8MERGO10K	Titanium 18 TIG Torch 25ft c/w Swivel Dinse with 10K Potentiometer + Jasic Plug
---	<b>TIG torch options for JT-202A water cooled package</b>
TIG-83ERGO	Titanium 18 TIG Torch 12.5ft c/w Adaptor + Jasic Plug
TIG-83ERGO-FLEXI	Titanium 18 Flexi TIG Torch 12.5ft c/w Adaptor + Jasic Plug
TIG-83-8MERGO	Titanium 18 TIG Torch 25ft c/w Swivel Dinse + Jasic Plug
TIG-83F-8MERGO	Titanium 18F TIG Torch 25ft c/w Swivel Dinse + Jasic Plug
TIG-83-8MERGO10K	Titanium 18 TIG Torch 25ft c/w Swivel Dinse with 10K Potentiometer + Jasic Plug
---	<b>Accessories</b>
JTT-MWD	Trolley (to suit water cooled package)
JWC-MWD	Water Cooler
TBC	Spacer box (used in place of water cooler for air cooled setup on trolley)
JSG-PLUG-9PIN	TIG Torch Switch Plug
JFC-08	Jasic Remote Foot Control
WCS50-5	Welding Cable Set (MMA) 5m (50mm Cable)
WC-2-03LD	Electrode Holder and Lead 3m
EC-2-03LD	Work Return Lead and Clamp 3m
CP3550	Cable Plug 35-50mm
SSARG1GPS	Single Stage 1 Gauge Argon Pre Set Regulator
FLOW14	0-14LPM Flowmeter
SSARG2G	Single Stage 2 Gauge Argon Regulator
JH-HDX	Jasic HD True Colour Auto Darkening Welding Helmet

# SCHEMATIC

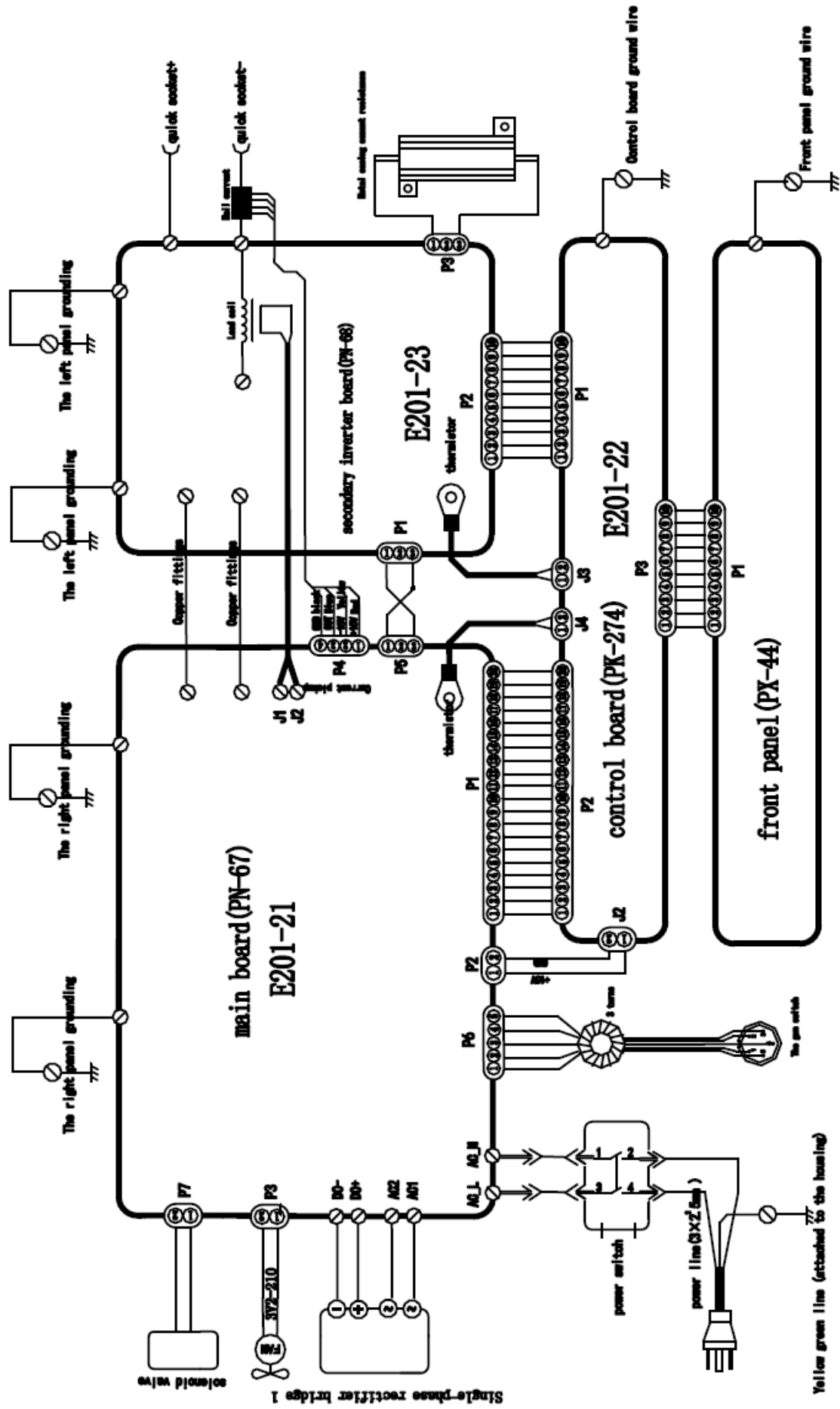

## NOTES

---

---

---

---

---

---

---

---

---

---

---

---

---

---

---

---

---

---

---

---

---

---

---

---

---

---

---

---

---

**Wilkinson Star Limited**

Shield Drive

Wardley Industrial Estate

Worsley

Manchester

UK

M28 2WD

**+44 (0)161 793 8127**



[www.jasic.co.uk](http://www.jasic.co.uk)

November 2022 - Issue 8