

**RADIODETECTION®** 

# RD8200™

Multifunction precision  
cable and pipe locators

User Guide

Guía del usuario

Guide d'utilisation

Návod k použití

用户指南

Gebruikershandleiding

Bedienungsanleitung

دليل المستخدم

90/RD8200-UG-INT/02



**SPX®** 

ENGLISH	3
ESPAÑOL	28
FRANÇAIS	54
ČESKÝ	82
中文	108
NEDERLANDS	132
DEUTSCH	160
186	عربي

## Preface

### About this guide

**CAUTION: This guide provides basic operating instructions for the RD8200 locator and transmitter. It also contains important safety information and guidelines and as such should be read in its entirety before attempting to operate the RD8200 locator and transmitter.**

This guide is intended as a quick reference guide only. For detailed instructions, including the use of accessories, help with eCert™, CALSafe™, Survey measurements and usage-logging\* please refer to the RD8200 locator operation and RD Manager™ Online manuals, which are available for download from [www.radiodetection.com](http://www.radiodetection.com).

The online User Manual library also contains links to the RD Manager Online manuals. Certificates of conformity for the RD8200 locators and Tx transmitter ranges can be found at [www.radiodetection.com](http://www.radiodetection.com).

\*Logging and GPS models only

**⚠ WARNING!** Direct connection to live conductors is **POTENTIALLY LETHAL**. Direct connections to live conductors should be attempted by fully qualified personnel only using the relevant products that allow connections to energized lines.

**⚠ WARNING!** The transmitter is capable of outputting potentially lethal voltages. Take care when applying signals to any pipe or cable and be sure to notify other technicians who may be working on the line.

**⚠ WARNING!** Reduce audio level before using headphones to avoid damaging your hearing.

**⚠ WARNING!** This equipment is **NOT** approved for use in areas where hazardous gases may be present.

**⚠ WARNING!** When using the transmitter, switch off the unit and disconnect cables before removing the battery pack.

**⚠ WARNING!** The RD8200 locator will detect most buried conductors but there are some objects that do not radiate any detectable signal. The RD8200, or any other electromagnetic locator, cannot detect these objects so proceed with caution. There are also some live cables which the RD8200 will not be able to detect in Power mode. The RD8200 does not indicate whether a signal is from a single cable or from several in close proximity.

**⚠ WARNING!** Batteries can get hot after prolonged use at full output power. Take care while replacing or handling batteries.

**⚠ WARNING!** Only use charging equipment provided by Radiodetection. The use of alternative chargers may cause a safety hazard and/or reduce the life of the battery.

**CAUTION:** Do not let your battery completely discharge as this may reduce its life or damage it permanently. If you are not using your equipment for a long period charge them at least once a month.

**⚠ WARNING!** Do not tamper with, or attempt to disassemble the battery packs.

**CAUTION:** If battery failure is suspected or if the battery shows any sign of discoloration / physical damage return the entire unit to an authorized repair center for investigation and repair. Local, national or IATA transport regulations may restrict the shipment of faulty batteries. Check with your courier for restrictions and best practice guidelines. Your local Radiodetection representative will be able to direct you to our authorized repair centers.

**NOTE:** The charging temperature range is 0 to 45 °C, 32 to 113°F. Do not attempt to recharge your batteries outside this temperature range.

## 3 Year Extended Warranty

RD8200 locators and transmitters are covered by a 1 year warranty as standard. Customers can extend their warranty period to a total of 3 years by registering their products within 3 months of purchase.

### To register your product:

Visit <https://portal.radiodetection.com> to create your portal account\* and use the Product page to register your locator or transmitter.

Visit <https://support.radiodetection.com> for instructions on how to create a portal account or register your product.

\*A valid email address and mobile number are required.

## eCert and Self-Test

The RD8200 locator is safety equipment which should be regularly checked to ensure its correct operation.

eCert provides a thorough test of the RD8200's locating circuitry, and supplies a Radiodetection Calibration Certificate when a positive test result is obtained.

To run an eCert, the locator should be connected to an internet-enabled PC on which the RD Manager software is installed.

Refer to the RD Manager operation manual for further details. Additional purchase may be required.

RD8200 locators incorporate an Enhanced Self-Test feature. In addition to the typical checks for display and power functions, the RD8200 applies test signals to its locating circuitry during a Self-Test to check accuracy and performance.

We recommend that a self-test is run at least weekly, or before each use.

# RD8200 locator

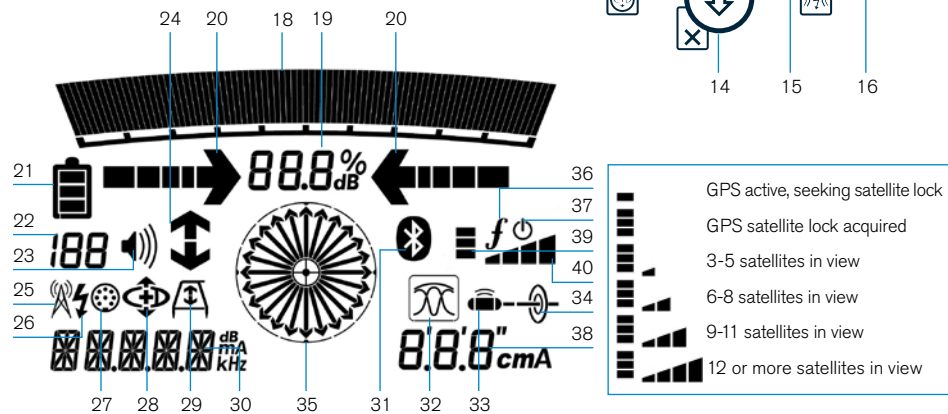
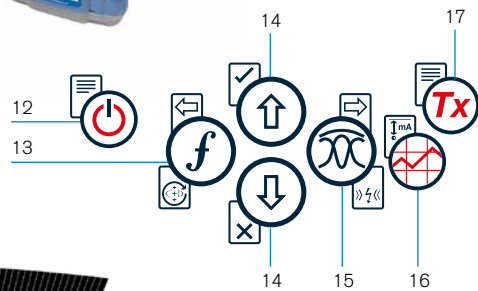

## Locator features

1. Keypad.
2. LCD with auto backlight.
3. Haptic (vibration) feedback.
4. Speaker.
5. Battery compartment.
6. Accessory connector.
7. Headphone connector.
8. Bluetooth® modules.
9. Swing alert system.
10. Optional Lithium-Ion battery pack.
11. USB port (inside battery compartment).
24. Current Direction arrows.
25. Radio Mode icon.
26. Power Mode icon.
27. Accessory / Measurement icon.
28. CD Mode icon.
29. A-Frame icon.
30. Frequency / current / menu readout.
31. Bluetooth status icon: Flashing icon means pairing is in progress. Solid icon indicates a connection is active.
32. Antenna mode icon: Indicates antenna mode selection: Peak / Null / Broad Peak / Peak+™ / Guidance.
33. Sonde icon: Indicates that a sonde signal source is selected.
34. Line icon: Indicates that a line signal source is selected.
35. Compass: Shows the orientation of the located cable or sonde relative to the locator.

## Locator keypad

12. Power key.
13. Frequency key.
14. Up and down arrows.
15. Antenna key.
16. Survey key.
17. Transmitter key.

## Locator screen icons

18. Signal strength bargraph with peak marker.
19. Signal strength readout.
20. Null / Proportional Guidance arrows.
21. Battery level.
22. Sensitivity readout / Log number.
23. Volume level.

## GPS equipped locators only:

36. Transmitter communication status – confirms successful iLOC™ communication.
37. Transmitter standby indicator.
38. Depth readout.
39. GPS Status.
40. GPS Signal quality.

# Tx-5 and Tx-10 transmitters

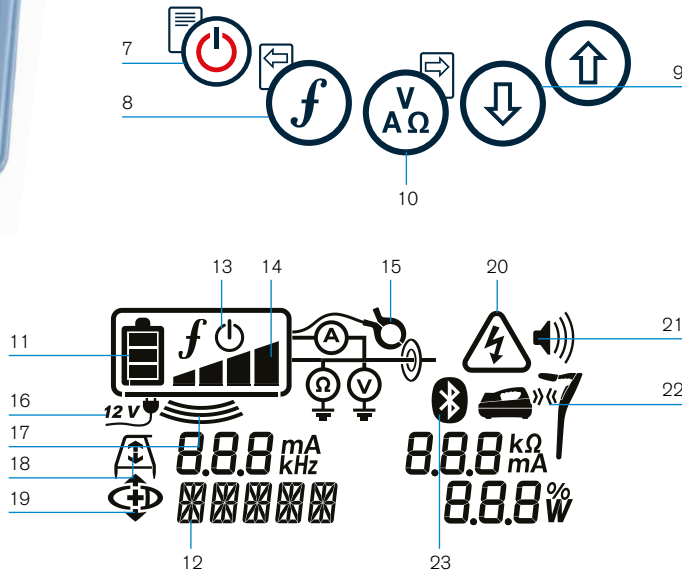

## Transmitter features

- Keypad.
- LCD.
- Removable accessory tray.
- D-cell battery tray.
- Optional Lithium-Ion battery pack.
- Bluetooth module (iLOC units).

## Transmitter keypad

- Power key.
- Frequency key.
- Up and down arrows.
- Measure key.

## Transmitter screen icons

- Battery level indicator.
- Operation mode readout.
- Standby icon.
- Output level indicator.

## iLOC enabled transmitters only:







- Pairing icon: Appears when the transmitter and locator are connected via iLOC.
- Bluetooth icon: Indicates status of Bluetooth connection. Flashing icon means pairing is in progress.









## Keypad actions and shortcuts



Switch the locator or transmitter on by pressing the  key. Once powered up, the keys function as follows:

### Locator keys

KEY	● SHORT PRESS	▬ LONG PRESS
	Enter the menu	Switch power off
	Scroll through locate frequencies from low to high	SideStep™ (see 'iLOC' section) When using Current Direction™: Perform a CD Reset
	When using active frequencies: Toggles Peak, Peak+, Null, Broad Peak and Guidance antenna modes. In Power Mode: Scrolls through Power Filters™ for improved discrimination of parallel or strong power signals	In Peak+ antenna mode: Switch between Guidance and Null arrows
 and 	Increase and decrease gain. RD8200 automatically sets gain to mid-point when pressed	Rapidly increase and decrease gain steps in 1dB increments
	Take a Survey Measurement and send over Bluetooth if paired	-
	Send an iLOC command to a paired transmitter	Enter the Transmitter power setting menu for use over iLOC

### Transmitter keys

KEY	● SHORT PRESS	▬ LONG PRESS
	Enter the menu	Switch Power off
	Scroll through locate frequencies from low to high	-
	Take voltage and impedance measurements using the currently selected frequency	Take voltage and impedance measurements at a standardized frequency
 and 	Adjusts the output signal	Select standby  / maximum standard power 

Tip: to scroll through frequencies from high to low, hold  while pressing the  button (applies to both locators and transmitters).

## Before you begin

### IMPORTANT!

This guide is intended to be a quick reference guide. We recommend you read the full operation manual before you attempt to operate the RD8200 locator.

### First use

The RD8200 locators and transmitters can be powered by D-cell alkaline batteries, D-cell NiMH batteries, or by an accessory Lithium-Ion (Li-Ion) battery pack.

To fit the D cell batteries in the locator, open the battery compartment and insert two D-Cell Alkaline or NiMH batteries, taking care to align the positive (+) and negative (-) terminals as indicated.

To fit the D cell batteries in the transmitter, unlatch the accessory tray. The battery compartment is located underneath the transmitter body. Unlatch the battery compartment. Insert eight D-Cell Alkaline or NiMH batteries, taking care to align the positive (+) and negative (-) terminals as indicated.

Alternatively, you can power the transmitter from a mains or vehicle power source using a Radiodetection supplied optional accessory adapter.

### Rechargeable battery packs





Lithium-Ion battery packs are available for both locators and transmitters, providing superior performance over traditional alkaline batteries. To fit these rechargeable packs, follow the instructions provided with each pack.

### System setup









It is important that you set up the system according to regional / operational requirements and your personal preferences before you conduct your first survey. You can set the system up using the menus as described below.

# Setting up your system

The RD8200 locator and transmitter menus allow you to select or change system options. Once entered, the menu is navigated using the arrow keys. Navigation is consistent on both the transmitter and the locator. When in the menu, most on-screen icons will temporarily disappear and the menu options will appear in the bottom left-hand corner of the display. The right arrow enters a submenu and the left arrow returns to the previous menu.

Note that when browsing the locator menu, the  and  keys act as left and right arrows. When browsing the transmitter menu, the  and  keys act as left and right arrows.

## To navigate menus:

1. Press the  key to enter the menu.
2. Use the  or  keys to scroll through the menu options.
3. Press the  key to enter the option's submenu.
4. Use the  or  keys to scroll through the submenu options.
5. Press the  key to confirm a selection and return to the previous menu.
6. Press the  key to return to the main operation screen.

**NOTE: When you select an option and press the  key, the option will be enabled automatically.**

## Locator menu options

- VOL: Adjust the speaker volume from 0 (mute) to 5 (loudest).
- SMLOG: enable or disable Bluetooth used for Survey Measurements, reset BT, pair with external device, select BT protocol and send survey measurement logs via BT
- ILOC: Enable, disable, reset or pair iLoc connections.
- GPS: Enable or disable the internal GPS module ,select an external GPS source and reset internal GPS.
- CDR: Perform a Current Direction (CD) Reset. (Alternatively press and hold the  key when in CD mode).
- UNITS: Select metric or imperial units.
- UTIL: Enable or disable utility selection
- ULIST: Utility selection
- LANG: Select menu language.
- POWER: Select local power network frequency: 50 or 60Hz.
- ANT: Enable or disable any antenna mode with the exception of Peak.
- FREQ: Enable or disable individual frequencies.
- ALERT: Enable or disable StrikeAlert™.
- BATT: Set battery type: Alkaline or NiMH. Li-Ion auto-selects when connected.
- ARROW: Select Null or proportional Guidance arrows in Peak+ mode

- COMP: Enable or disable display of the Compass feature.
- VALRT: Enable or disable the vibration feature.
- AUDIO: Select High or Low sound levels.
- SWING: Enable or disable Swing measurement.
- INFO: Shows the software version, run a Self-Test, display the date of the most recent service recalibration (M CAL) or the most recent eCert calibration.







## Transmitter menu options

- VOL: Adjust the speaker volume from 0 (mute) to 3 (loudest).
- FREQ: Enable or disable individual frequencies.
- BOOST: Boost transmitter output for a specified period of time (in minutes).
- INFO: Shows the software version
- LANG: Select menus language.
- OPT F: Run SideStep<sup>auto</sup>™ to auto-select a locate frequency for the connected utility.
- BATT: Set battery type: ALK, NiMH or Li-ION and enable / disable Eco mode.
- MAX P: Set the transmitter to output its maximum wattage.
- MODEL: Match the transmitter setting to the model of your locator.
- MAX V: Set the output voltage to maximum (90V).
- ILOC: Enable, disable or pair iLOC connections (Bluetooth models only).

## Examples of using the menu, selecting options and making changes:

### Locator mains power frequency







To select the correct frequency (50 or 60Hz) for your country or region's power supply:

1. Press the  key to enter the menu.
2. Scroll to the POWER menu using the  or  keys.
3. Press the  key to enter the POWER menu.
4. Use the  or  keys to select the correct mains frequency.
5. Press the  key twice to accept your selection and return to the main operation screen.

## Batteries











It is important to set the system to match the currently installed battery type to ensure optimal performance and correct battery level indication.

To set your battery type:

1. Press the  key to enter the menu.
2. Scroll to the BATT menu using the  or  arrows.
3. Press the  key (on the locator) or the  key (on the transmitter) to enter the BATT menu.
4. Scroll up or down to select the correct battery type (Alkaline, Nickel-metal Hydride or Lithium-Ion). Lithium-Ion is automatically selected when a Li-Ion pack is connected to a Locator.
5. Press the  key twice to accept your selection and return to the main operation screen.

## Transmitter Eco Mode

When using alkaline batteries, Eco mode can be selected to maximize run time. When Eco mode is selected the transmitter automatically reduces its maximum power output as battery levels run low. Eco mode is switched off by default. To Enable Eco Mode:

1. Press the  key to enter the menu.
2. Scroll to the BATT menu using the  or  arrows.
3. Press the  key to enter the BATT menu.
4. Select the ALK Battery type using the  or  arrows.
5. Press the  key to enter the ECO sub menu
6. Select ECO using the  or  arrows.
7. Press the  key three times to accept your selection and return to the main operation screen.

## Locating pipes and cables



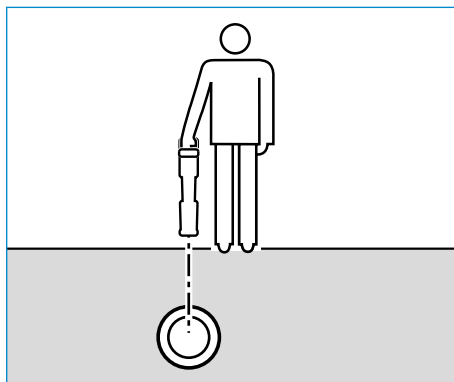

For more detailed descriptions of using the locator and transmitter, and for detailed locate techniques, refer to the RD8200 Operation Manual.

The RD8200 locator is designed to operate with the 'blade' of the locator perpendicular to the path of the cable or pipe being located.



## SideStepauto™

The transmitter can be used to recommend a general-purpose locate frequency for the intended locate task by measuring the impedance of the target cable or pipe. To run SideStepauto™, connect the transmitter to the target utility, then:

1. Press the  key to enter the menu.
2. Scroll to the OPT F menu using the  or  arrows.
3. Press the  key to select START.
4. Press the  key to start the test. The transmitter will automatically select a general purpose frequency for use on the connected utility.

## Locating with Active Frequencies

Active frequencies are applied to the target pipe or cable using the transmitter, and provide the most effective way of tracing buried pipes or cables.

Generally speaking, it is better to use a low frequency on larger, low impedance utilities, and move to a higher frequency on smaller, high impedance utilities.

The lowest power setting required to trace the target utility should always be used to minimize the risk of false trails.

The transmitter can apply a signal using three different methods:

### Direct connection

In direct connection, you connect the transmitter directly to the pipe or cable you wish to survey using the red Direct Connect lead supplied. The black lead is generally connected to earth using the supplied ground stake.

The transmitter will then apply a discrete signal to the line, which you can trace using the locator. This method provides the best signal on an individual line and enables the use of lower frequencies, which can be traced for longer distances.

**⚠ WARNING! Direct connection to live conductors is POTENTIALLY LETHAL. Direct connections to live conductors should be attempted by fully qualified personnel only using the relevant products that allow connections to energized lines.**

### Induction

The transmitter is placed on the ground over or near the survey area. You select the appropriate frequency. The transmitter will then induce the signal indiscriminately to any nearby metallic conductor. In induction mode, using higher frequencies is generally recommended as they are induced more easily onto nearby conductors.



## Transmitter Clamp

An optional signal clamp can be placed around an insulated live wire or pipe up to 8.5" / 215mm in diameter to transfer the transmitter signal to the utility. This method of applying the transmitter signal is particularly useful on insulated live wires and removes the need to disconnect the supply to the cable.

**⚠ WARNING! Do not clamp around uninsulated live conductors.**

**⚠ WARNING! Before applying or removing the clamp around a power cable ensure that the clamp is connected to the transmitter at all times.**

## Locating with Passive Frequencies

Passive frequency detection takes advantage of signals that are already present on buried metallic conductors. The RD8200 supports four types of passive frequencies: Power, Radio, CPS and Cable TV (CATV) signals. You can detect these frequencies without the aid of the transmitter.

### Power Filters

RD8200 locators allows operators to take advantage of the harmonic signals found on power networks. Once in Power Mode, press the  key to switch out of Radiodetection's sensitive Power Mode and scroll through five individual Power Filters. This enables operators to establish if a single large power signal comes from one source or from the presence of multiple cables. The different harmonic characteristics of the detected lines can then be used to trace and mark their route.

Additionally the use of an individual harmonic can allow you to locate power lines in situations where the total signal would otherwise be too large.

## Locate Modes

The RD8200 offers a choice of 5 locate modes, each of which is designed for specific uses, depending on what task is being carried out.

To scroll between locate modes, press the  key.



**PEAK:** For accurate locating, the peak bargraph provides a visual readout of the signal strength. The peak signal is found directly over the buried utility.



**PEAK+:** Choose to combine the accuracy of the Peak bargraph with Null arrows, which can indicate the presence of distortion, or with proportional Guidance arrows for rapid line tracing – switch between them by holding the  key.



**GUIDANCE:** Proportional arrows and a ballistic 'needle' combine with audio left/right indication for rapidly tracing the general path of a buried utility.



**BROAD PEAK:** Operating similarly to Peak mode, but giving a result over a wider area. Used to detect and trace very weak signals, for example very deep utilities.



**NULL:** Provides a quick left/right indication of the path of a utility. As Null is susceptible to interference, it is best used in areas where no other utilities are present.

## Depth, current and compass readouts

**⚠ WARNING! Never use the depth measurement readout as a guide for mechanical or other digging activity. Always follow safe digging guidelines.**

The RD8200 locator can measure and display the utility depth, locate signal current and the relative orientation of the cable or pipe to the locator. This helps you to make sure that you are following the right cable or pipe, especially when other utilities are present.

The RD8200 locator features TruDepth™, a feature that helps you to ensure the accuracy of your locates or Survey Measurements. The depth and current are automatically removed from the display when the locator is at an angle of more than 7.5° from the path of the cable or pipe being located, or when the locator determines that signal conditions are too poor for reliable measurements.

### Current Direction (CD)

The Tx-10 transmitter range can apply a unique CD signal onto a pipe or cable. This signal can be used to identify an individual pipe or cable amongst a number of parallel utilities, ensuring operators follow the right line. A CD signal clamp or direct connection leads can be used to apply the unique signal to the pipe or cable and a CD locator clamp or CD stethoscope can be used to identify individual pipes or cables.

## Using accessories

The locator and transmitter are compatible with a wide range of accessories. For detailed information on using any of the accessories below please refer to the RD8200 locator operation manual.

### Transmitter signal clamps

When it is not possible to connect directly onto a pipe or cable, or induction mode is unsuitable, a transmitter signal clamp may be used. The clamp is plugged into the output of the transmitter and provides a means of applying a locate signal to an insulated live wire. This is particularly useful with live insulated cables as it removes the need to disable the power and break the line.

**⚠ WARNING! Do not clamp around uninsulated live conductors.**

**⚠ WARNING! Before applying or removing the clamp around a power cable ensure that the clamp is connected to the transmitter at all times.**

To locate or identify individual lines a locator signal clamp can be connected to the accessory socket of the locator and can be clamped around individual pipes or cables.

## Stethoscopes and locator signal clamps

Locator clamps can be used to identify a target cable or pipe amongst a number of different cables by checking for the strongest locate signal. When cables are bunched or tightly packed, a stethoscope antenna can be used in place of a clamp.

To use a stethoscope or locator signal clamp, connect it to the locator's accessory socket. The locator will automatically detect the device and filter out location modes that are irrelevant.

## Sondes, Flexrods and FlexiTrace

Sondes are battery powered transmitters that are useful for tracing non-metallic pipes. They can be fixed to Flexrods to allow them to be pushed through pipes or conduits, and some are suitable for blowing through ductwork.

For a detailed guide on locating sondes, please refer to the operation manual.

A FlexiTrace is a traceable fiberglass rod incorporating wire conductors with a sonde at the end. It is connected to the output of the transmitter and is typically used in small diameter, non-metallic pipes. The user has the option of locating the entire length of the cable or choosing to locate only the tip of the cable.

The FlexiTrace has a maximum power rating of 1W. When using the FlexiTrace with a Radiodetection Tx-5(B) or Tx-10(B) transmitter the output limit must be set to 1W in the MAX P menu and the output voltage limit set to LOW in the MAX V menu.

## Fault-finding with an A-Frame

The RD8200 models has the ability to detect cable or pipe insulation faults accurately using an A-Frame accessory. The Tx-5 and Tx-10 models provide fault finding signals that can be detected by the A-Frame as a result of the signal bleeding to ground through damaged cable sheaths.

The Transmitter's multimeter function can be used to measure the impedance of the connected pipe or cable in order to characterize the fault.

For a detailed guide to fault-finding, please refer to the operation manual.

## Plug / Live cable connector

The plug connector is connected to the output of the transmitter and is used to put a signal onto a line and trace it from a domestic mains plug to the service cable in the street.

The live cable connector can be used to apply a signal to a live cable. Only suitably qualified personnel should use this equipment.

## Submersible antenna

This antenna is connected to the locator and used to locate pipes and cables underwater at depths of up to 300 feet / 100 meters.

**⚠ WARNING: use of the submersible antenna should be by fully licensed and experienced personnel only, and only after fully reading the operation manual!**

## Bluetooth wireless connections









RD8200 locators feature a Bluetooth wireless module, as standard, providing the ability to connect to compatible devices such as transmitters (Bluetooth models), PCs, laptops or handheld devices running a compatible application.

**NOTE: The RD8200 locator wireless features may be subject to national and or local regulations. Please consult your local authorities for more information.**

**⚠ WARNING! Do not attempt any wireless connection in areas where such technology is considered hazardous. This may include: petrochemical facilities, medical facilities or around navigation equipment.**

## Switching iLOC on

By default RD8200 locators and Bluetooth enabled transmitters are shipped with the iLOC wireless connection module disabled.

1. Press the  key to enter the menu.
2. Scroll to the iLOC menu using the  or  keys.
3. Press the  key (locator) or the  key (transmitter) to enter the iLOC menu.
4. Press the  or  keys to select the ON option.
5. Press the  key to confirm selection and return to the previous menu.
6. A further press of the  key will return to the main operating screen.

You can switch Bluetooth off to conserve battery life, or to comply with regulations in areas where wireless communications are considered hazardous. To do this, follow the above process, selecting 'OFF' in the iLOC menu.

## Bluetooth error codes

If an error occurs when attempting to perform any Bluetooth command using the locator to the transmitter or the locator to a PC or paired device, the LCD will display a code to help you resolve the problem on the locator.

The codes are as follows:

BT CODE	DESCRIPTION
BT001	Bluetooth not configured for this unit
BT002	Internal Bluetooth error
BT003	Locator not paired with transmitter
BT004	Locator not paired with PC / external compatible device
BT005	Paired but connection attempt failed. Power cycling may be required
BT006	Corrupt response received from transmitter
BT007	Indeterminate response received from transmitter
BT008	No response received from transmitter
TX??	Transmitter unable to change to the requested frequency

## Taking Survey Measurements

RD8200 locator models are capable of recording measurements at up to 1000 survey points, and optionally sending them to an external device using Bluetooth.

If the locator is a GPS model or if paired to an external device with GPS that is running a compatible application the locator will append positional information alongside time and date to the data, providing spatial context.

**NOTE: The internal GPS module needs to be switched on and connected to the GPS satellite system.**











### Saving measurements

To save survey measurements, press the  key.

To achieve accurate results the locator must be kept as still as possible during the saving process.

The locator will always save measurements to internal memory. If Bluetooth is switched on and paired to a device, the locator will also attempt to send the saved measurement to a paired device running a compatible application.











### To disable the Bluetooth:

1. Press the  key to enter the menu.
2. Scroll to the SMLOG menu using the  or  keys.
3. Press the  key to enter the SMLOG menu.
4. Press the  or  keys to select COM
5. Press the  key to enter the COM menu.
6. Press the  or  keys to select OFF
7. Press the  key 3 times to go back to the main locator screen.

### Erasing measurements

The RD8200 locator allows you to delete all measurements. Erasing the log will wipe the RD8200 memory and is usually recommended when you begin a new survey.











**NOTE: Erasing measurements cannot be undone!**

1. Press the  key to enter the menu.
2. Press the  or  keys to select SMLOG menu.
3. Press the  key to enter the SMLOG menu.
4. Press the  or  keys to select DATA
5. Press the  key to enter the DATA menu.
6. Press the  or  keys to select the DEL option.
7. Press the  key once to make the selection and twice more to return to the main locator screen.

### To send stored data to a paired device:

Stored data can be transferred wirelessly to a compatible device running Radiodetection's RD Map app or another compatible application.

### To send data to a paired device:

1. Ensure your paired device is switched on and running a compatible app, such as RD Map for Android.
2. Press the  key to enter the menu.
3. Scroll to the SMLOG menu using the  or  keys.
4. Press the  key to enter the SMLOG menu.
5. Press the  or  keys to select DATA
6. Press the  key to enter the DATA menu.
7. Press the  or  keys to select SEND
8. Press the  key once to send the data logs and twice more to return to the main locator screen.

## Automatic Usage-Logging

RD8200 locator models equipped with GPS offer a powerful data logging system which records all the instrument's critical parameters (including GPS position, if available) and warnings in its internal memory every second.

The automatic logging system is always active and cannot be disabled. The locator's memory is capable of storing over 500 days of usage data, when used for 8 hours per day.

Logs can be retrieved using the RD Manager Online PC application for usage analysis and survey validation. Refer to the RD Manager Online operation manual for further information.

## GPS

The RD8200 locator can be paired to an external GPS module (option) or use its internal GPS module (GPS models only) to be able to detect and store its latitude, longitude and accurate UTC time alongside its location data. This positional information can then be appended to Survey Measurements, or the automatic usage-logging system.

The presence of GPS data allows for the data to be mapped easily and to export and save the information directly into GIS systems.

## GPS menu settings

There are 4 options in the GPS menu:

- INT: Select this to use the internal GPS if present.
- EXTM: Select this to use the GPS from a compatible paired device.
- OFF: Select this to switch off the internal GPS module and save battery.
- RESET: Select YES to reset the internal GPS (GPS models only).

## iLOC

iLOC lets you control the transmitter remotely using your RD8200 locator. With iLOC you can adjust the output frequency, power settings and use SideStep. iLOC commands are sent over a Bluetooth module that can operate at distances of up to 450m/ 1400ft in direct line of sight.

iLOC is a standard feature of all RD8200 locator models, and requires a Bluetooth equipped Transmitter.







**NOTE: Operating in built up areas and in areas with high electromagnetic interference may reduce iLOC's performance.**

## Pairing to a transmitter

To pair to a transmitter you require a iLOC enabled model such as the Tx-10B, Tx-10L or Tx-10G.







Before you begin, you should switch off all nearby Bluetooth equipment as they may interfere with the locator and transmitter's pairing process.

### Preparing the locator:

1. Press the  key to enter the menu.
2. Scroll to the iLOC menu using the  or  keys.
3. Press the  key to enter the iLOC menu.
4. Scroll to the PAIR menu using the  or  keys.

**NOTE: You must complete the pairing process within 90 seconds to prevent the locator's Bluetooth connection from timing out.**

### Preparing the transmitter:

5. Press the  key to enter the menu.
6. Scroll to the iLOC menu using the  or  keys.
7. Press the  key to enter the iLOC menu.
8. Scroll to the PAIR menu using the  or  keys.

## Starting the pairing process:

9. Press the  key on the locator and transmitter.
10. The transmitter and the locator will now attempt to pair.

When pairing is in progress, the transmitter and locator will display a flashing Bluetooth icon. Pairing can take up to a minute. If the pairing process is successful, the transmitter will display the  icon and the locator will display a persistent Bluetooth icon for the duration of the connection.

If pairing fails, ensure that any nearby Bluetooth devices are switched off or invisible then repeat the process.

Once the locator and transmitter have successfully paired you can use iLOC to change the transmitter's output frequency and power levels remotely from the locator.

## Using iLOC

The locator and transmitter need to be paired to use iLOC. For optimum performance:

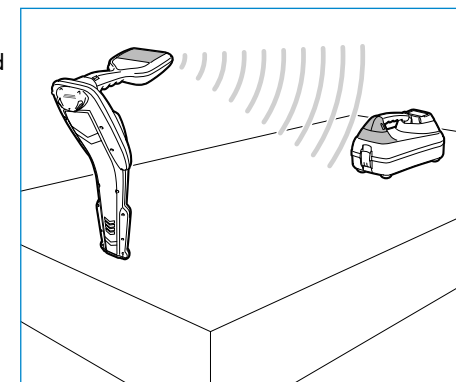

- Try to minimize obstructions in line of sight.
- If possible, raise the transmitter off the ground by 30-60cm (1-2ft).
- Face the rear end of the transmitter towards the locator.
- Point the screen of the locator towards the transmitter.



**NOTE: If any iLOC commands fail, move closer to the transmitter and repeat the process.**

## Changing frequencies

Once the transmitter and the locator are paired, you can change the transmitter's output frequency remotely using the locator:

1. On the locator, select the frequency you want by pressing the  key until the frequency is displayed on screen.
2. Press the  key to send the new frequency to the transmitter.
3. The locator will display SEND momentarily and then OK if the transfer is successful.
4. If the transfer is unsuccessful, the locator will display a Bluetooth error code error code.

If the process fails, you may be out of range or there may be an error in the connection. Move closer to the transmitter and retry the procedure. If the connection continues to fail, return to the transmitter and reset the connection.

## Adjusting power

iLOC lets you adjust the transmitter's power output remotely; you can also put the transmitter into standby mode and then wake it remotely.

1. Transmitter power options are located in the TXOUT menu on the locator. Press and hold the **(Tx)** key to display the TXOUT menu.
2. Press the **(⏏)** key to enter the power level menu.
3. Scroll up or down through the power output options using the **(↑)** or **(↓)** keys:
  - **STDBY:** Transmitter standby mode, the connection is still active but the output is disabled – use to prolong battery life.
  - **LOW:** Low power output.
  - **MED:** Medium power output.
  - **HIGH:** High power output.
  - **BOOST:** Temporarily boosts transmitter power output to its maximum level.
4. Once you have selected the mode you want, press the **(f)** key to confirm.
5. Press and hold the **(Tx)** key to select the new setting and exit the menu.
6. Press the **(Tx)** key once to send the settings to the transmitter.

**NOTE:** When changing the transmitter frequency using iLOC, the chosen transmitter power setting will be retained.

## SideStep

SideStep allows you to change the output frequency on the transmitter. SideStep changes the selected frequency by several Hertz and automatically sets the locator's locate frequency to match the transmitter's output frequency.

1. On the locator, select the frequency you want by pressing the **(f)** key until the frequency is displayed on screen.
2. To step the frequency, press and hold the **(f)** key until **STEP** appears on the LCD.
3. Press the **(Tx)** key to send the SideStep command to the transmitter.
4. If the command is sent successfully, an asterisk (\*) will appear on the locator next to the frequency and STEP will appear on the transmitter below the frequency.
5. To return to the standard locate frequency, press and hold the **(f)** key. Once the asterisk (\*) has been removed from the display, press the **(Tx)** key to send the command to the transmitter

## CALSafe

RD8200 locators are equipped with a system which can be enabled to force them to shut down once they are beyond the expected service / calibration date.

When the unit is within 30 days of the service due date the unit will display at startup the number of days left. The locator will stop functioning on the service due date.

CALSafe is disabled by default. You can enable the CALSafe feature and edit the CALSafe service / calibration due date using the RD Manager Online PC software. Refer to the RD Manager Online operation manual for further information.

## Training

Radiodetection provides training services for most Radiodetection products. Our qualified instructors will train equipment operators or other personnel at your preferred location or at Radiodetection headquarters. For more information go to [www.radiodetection.com](http://www.radiodetection.com) or contact your local Radiodetection representative.

## Care and maintenance

The RD8200 locator and transmitter are robust, durable and weatherproof. However you can extend your equipment's life by following these care and maintenance guidelines.

### General

Store the equipment in a clean and dry environment.

Ensure all terminals and connection sockets are clean, free of debris and corrosion and are undamaged.

Do not use this equipment when damaged or faulty.

### Batteries and power supply

Only use the rechargeable battery packs, chargers and power supplies approved by Radiodetection.

If not using rechargeable packs, use good quality Alkaline or NiMH batteries only.

Batteries should be disposed of in accordance with your company's work practice, and/ or any relevant laws or guidelines in your country.

## Cleaning

**⚠ WARNING! Do not attempt to clean this equipment when it is powered or connected to any power source, including batteries, adapters and live cables.**

Ensure the equipment is clean and dry whenever possible.

Clean with a soft, moistened cloth. Do not use abrasive materials or chemicals as they may damage the casing, including the reflective labels. Do not use high pressure jets of water to clean the equipment.

If using this equipment in foul water systems or other areas where biological hazards may be present, use an appropriate disinfectant.

## Software upgrades

From time to time, Radiodetection may release software upgrades to enhance features and improve performance of the RD8200 locator or transmitter. Software upgrades are free of charge and provided through the RD Manager Online PC software

E-mail alerts and notification of new software releases are sent to all registered users. You can also check if your products are up-to-date or upgrade them by using the RD Manager Online software upgrade screen.

**NOTE: To upgrade your product's software you need to have created an account using RD Manager Online and have a live internet connection. An optional Radiodetection power supply may be required to update your transmitter software.**

## Disassembly

Do not attempt to disassemble this equipment under any circumstances. The locator and transmitter contain no user serviceable parts.

Unauthorized disassembly will void the manufacturer's warranty, and may damage the equipment or reduce its performance.

## Service and maintenance

Regularly check your equipment for correct operation by using the Self-Test function and eCert.

The locator and transmitter are designed so that they do not require regular recalibration. However, as with all safety equipment, it is recommended that they are serviced and calibrated at least once a year either at Radiodetection or an approved repair center.

**NOTE: Service by non-approved service centers may void the manufacturer's warranty.**

Details of Radiodetection offices and distribution partners can be found at [www.radiodetection.com](http://www.radiodetection.com).

Radiodetection products, including this guide, are under continuous development and are subject to change without notice. Go to [www.radiodetection.com](http://www.radiodetection.com) or contact your local Radiodetection representative for the latest information regarding the RD8200 locator or any Radiodetection product.









## Enhanced Self-Test

RD8200 locators incorporate an Enhanced Self-Test feature. In addition to the typical checks for display and power functions, the RD8200 applies test signals to its locating circuitry during a Self-Test to check accuracy and performance.

We recommend that a self-test is run at least weekly, or before each use.

## Running a Self-Test

We recommend that a Self-Test is run at least weekly, or before each use. As the Self-Test tests the integrity of the locate circuitry, it is important that it is carried out away from larger metallic object such as vehicles, or strong electrical signals. To run a Self-Test:

1. Press the  key to enter the menu.
2. Scroll to the INFO menu using the  or  arrows.
3. Press the  key to enter the INFO menu.
4. Select TEST using the  or  arrows.
5. Press the  key to select YES.
6. Press the  key to begin the Self-Test.
7. Once the Self-Test is completed, the result (PASS or FAIL) will be displayed.
8. Restart the locator using the  key.

## RD Manager Online PC Software

RD Manager Online is the RD8200 locator system PC companion, and it allows you to manage and customize your locator. RD Manager Online is also used to retrieve and analyze survey and usage data, run an eCert calibration, and to perform software upgrades.

You can use RD Manager Online to register your products to obtain an extended warranty, setup your locator by performing a number of maintenance tasks such adjusting date and time, activating and de-activating active frequencies, or by setting-up functions like CALSafe or StrikeAlert.

RD Manager Online is compatible with PCs running Microsoft Windows 64 bit operating system. To download RD Manager Online, go to [www.radiodetection.com/RDManager\\_Online](http://www.radiodetection.com/RDManager_Online).

If you do not have internet access, or wish to receive RD Manager Online on a USB flash drive, contact your local Radiodetection office or representative.

For more information about RD Manager refer to the RD Manager Online operation manual.

Visit [www.radiodetection.com](http://www.radiodetection.com)

## Global locations

### **Radiodetection Ltd. (UK) – Global Headquarters**

Western Drive, Bristol, BS14 0AF, UK Tel: +44 (0) 117 976 7776 [rd.sales.uk@spx.com](mailto:rd.sales.uk@spx.com)

### **Radiodetection (France)**

13 Grande Rue, 76220, Neuf Marché, France  
Tel: +33 (0) 2 32 89 93 60 [rd.sales.fr@spx.com](mailto:rd.sales.fr@spx.com)

### **Radiodetection (Benelux)**

Industriestraat 11, 7041 GD 's-Heerenberg, Netherlands  
Tel: +31 (0) 314 66 47 00 [rd.sales.nl@spx.com](mailto:rd.sales.nl@spx.com)

### **Radiodetection (Germany)**

Groendahlscher Weg 118, 46446 Emmerich am Rhein, Germany  
Tel: +49 (0) 28 51 92 37 20 [rd.sales.de@spx.com](mailto:rd.sales.de@spx.com)

### **Radiodetection (Asia-Pacific)**

Room 708, CC Wu Building, 302-308 Hennessy Road, Wan Chai, Hong Kong SAR, China  
Tel: +852 2110 8160 [rd.sales.asiapacific@spx.com](mailto:rd.sales.asiapacific@spx.com)

### **Radiodetection (China)**

13 Fuqianyi Street, Minghao Building D304, Tianzhu Town, Shunyi District,  
Beijing 101312, China Tel: +86 (0) 10 8146 3372 [rd.service.cn@spx.com](mailto:rd.service.cn@spx.com)

### **Radiodetection (Australia)**

Unit H1, 101 Rookwood Road, Yagoona NSW 2199, Australia  
Tel: +61 (0) 2 9707 3222 [rd.sales.au@spx.com](mailto:rd.sales.au@spx.com)

### **Radiodetection (USA)**

28 Tower Road, Raymond, Maine 04071, USA  
Toll Free: +1 (877) 247 3797 Tel: +1 (207) 655 8525 [rd.sales.us@spx.com](mailto:rd.sales.us@spx.com)

### **Schonstedt Instrument Company (USA)**

100 Edmond Road, Kearneysville, WV 25430 USA  
Toll Free: +1 888 367 7014 Tel: +1 304 724 4722 [schonstedt.info@spx.com](mailto:schonstedt.info@spx.com)

### **Radiodetection (Canada)**

Unit 34, 34-344 Edgeley Blvd. Concord, Ontario, ON L4K 4B7, Canada  
Toll Free: +1 (800) 665 7953 Tel: +1 (905) 660 9995 [rd.sales.ca@spx.com](mailto:rd.sales.ca@spx.com)

### **Sensors & Software Inc. (Canada)**

1040 Stacey Court Mississauga, Ontario L4W 2X8, Canada  
Toll-free: +1 800 267 6013 Tel: +1 (905) 624 8909 [sales@sensoft.ca](mailto:sales@sensoft.ca) [www.sensoft.ca](http://www.sensoft.ca)