

INSTRUCTION MANUAL

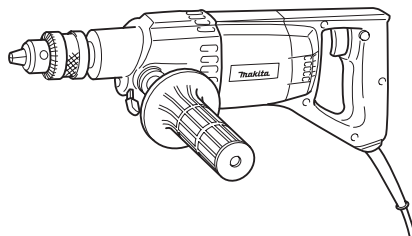

# Diamond Core Hammer Drill

## 8406



DOUBLE INSULATION



Read before use.



# SPECIFICATIONS

Model		8406	
Capacities	Concrete	Diamond core bit	152 mm
		Tungsten-carbide tipped bit	20 mm
	Steel	13 mm	
	Wood	30 mm	
No load speed (min <sup>-1</sup> )		0 - 1,500	
Blows per minute		0 - 22,500	
Overall length		400 mm	
Net weight		3.7 kg	
Safety class		□/II	

- Due to our continuing program of research and development, the specifications herein are subject to change without notice.
- Specifications may differ from country to country.
- Weight according to EPTA-Procedure 01/2014

## Symbols

The followings show the symbols which may be used for the equipment. Be sure that you understand their meaning before use.

	Read instruction manual.
	DOUBLE INSULATION
	Only for EU countries Do not dispose of electric equipment together with household waste material! In observance of the European Directive, on Waste Electric and Electronic Equipment and its implementation in accordance with national law, electric equipment that have reached the end of their life must be collected separately and returned to an environmentally compatible recycling facility.

### Intended use

The tool is intended for drilling in brick and concrete with diamond core bit. It is also suitable for impact drilling in brick, concrete and stone as well as for drilling without impact in wood, metal, ceramic and plastic.

### Power supply

The tool should be connected only to a power supply of the same voltage as indicated on the nameplate, and can only be operated on single-phase AC supply. They are double-insulated and can, therefore, also be used from sockets without earth wire.

### Noise

The typical A-weighted noise level determined according to EN62841-2-1:

- Sound pressure level ( $L_{pA}$ ) : 94 dB (A)
- Sound power level ( $L_{WA}$ ) : 105 dB (A)
- Uncertainty (K) : 3 dB (A)

**NOTE:** The declared noise emission value(s) has been measured in accordance with a standard test method and may be used for comparing one tool with another.

**NOTE:** The declared noise emission value(s) may also be used in a preliminary assessment of exposure.

**⚠ WARNING:** Wear ear protection.

**⚠ WARNING:** The noise emission during actual use of the power tool can differ from the declared value(s) depending on the ways in which the tool is used especially what kind of workpiece is processed.

**⚠ WARNING:** Be sure to identify safety measures to protect the operator that are based on an estimation of exposure in the actual conditions of use (taking account of all parts of the operating cycle such as the times when the tool is switched off and when it is running idle in addition to the trigger time).

### Vibration

The vibration total value (tri-axial vector sum) determined according to EN62841-2-1:

- Work mode: drilling into concrete  
Vibration emission ( $a_{h,DD}$ ) : 9.8 m/s<sup>2</sup>  
Uncertainty (K) : 1.5 m/s<sup>2</sup>
- Work mode: impact drilling into concrete  
Vibration emission ( $a_{h,ID}$ ) : 9.5 m/s<sup>2</sup>  
Uncertainty (K) : 1.5 m/s<sup>2</sup>
- Work mode: drilling into metal  
Vibration emission ( $a_{h,D}$ ) : 2.5 m/s<sup>2</sup> or less  
Uncertainty (K) : 1.5 m/s<sup>2</sup>

**NOTE:** The declared vibration total value(s) has been measured in accordance with a standard test method and may be used for comparing one tool with another.

**NOTE:** The declared vibration total value(s) may also be used in a preliminary assessment of exposure.

**⚠ WARNING:** The vibration emission during actual use of the power tool can differ from the declared value(s) depending on the ways in which the tool is used especially what kind of workpiece is processed.

**⚠ WARNING:** Be sure to identify safety measures to protect the operator that are based on an estimation of exposure in the actual conditions of use (taking account of all parts of the operating cycle such as the times when the tool is switched off and when it is running idle in addition to the trigger time).

## EC Declaration of Conformity

### For European countries only

The EC declaration of conformity is included as Annex A to this instruction manual.

## SAFETY WARNINGS

### General power tool safety warnings

**⚠ WARNING:** Read all safety warnings, instructions, illustrations and specifications provided with this power tool. Failure to follow all instructions listed below may result in electric shock, fire and/or serious injury.

### Save all warnings and instructions for future reference.

The term "power tool" in the warnings refers to your mains-operated (corded) power tool or battery-operated (cordless) power tool.

#### Work area safety

1. **Keep work area clean and well lit.** Cluttered or dark areas invite accidents.
2. **Do not operate power tools in explosive atmospheres, such as in the presence of flammable liquids, gases or dust.** Power tools create sparks which may ignite the dust or fumes.
3. **Keep children and bystanders away while operating a power tool.** Distractions can cause you to lose control.

#### Electrical safety

1. **Power tool plugs must match the outlet. Never modify the plug in any way. Do not use any adapter plugs with earthed (grounded) power tools.** Unmodified plugs and matching outlets will reduce risk of electric shock.
2. **Avoid body contact with earthed or grounded surfaces, such as pipes, radiators, ranges and refrigerators.** There is an increased risk of electric shock if your body is earthed or grounded.
3. **Do not expose power tools to rain or wet conditions.** Water entering a power tool will increase the risk of electric shock.
4. **Do not abuse the cord. Never use the cord for carrying, pulling or unplugging the power tool. Keep cord away from heat, oil, sharp edges or moving parts.** Damaged or entangled cords increase the risk of electric shock.
5. **When operating a power tool outdoors, use an extension cord suitable for outdoor use.** Use of a cord suitable for outdoor use reduces the risk of electric shock.
6. **If operating a power tool in a damp location is unavoidable, use a residual current device (RCD) protected supply.** Use of an RCD reduces the risk of electric shock.
7. **Use of power supply via an RCD with a rated residual current of 30 mA or less is always recommended.**
8. **Power tools can produce electromagnetic fields (EMF) that are not harmful to the user.** However, users of pacemakers and other similar medical devices should contact the maker of their device and/or doctor for advice before operating this power tool.

9. **Do not touch the power plug with wet hands.**
10. **If the cord is damaged, have it replaced by the manufacturer or his agent in order to avoid a safety hazard.**

#### Personal safety

1. **Stay alert, watch what you are doing and use common sense when operating a power tool. Do not use a power tool while you are tired or under the influence of drugs, alcohol or medication.** A moment of inattention while operating power tools may result in serious personal injury.
2. **Use personal protective equipment. Always wear eye protection.** Protective equipment such as a dust mask, non-skid safety shoes, hard hat or hearing protection used for appropriate conditions will reduce personal injuries.
3. **Prevent unintentional starting. Ensure the switch is in the off-position before connecting to power source and/or battery pack, picking up or carrying the tool.** Carrying power tools with your finger on the switch or energising power tools that have the switch on invites accidents.
4. **Remove any adjusting key or wrench before turning the power tool on.** A wrench or a key left attached to a rotating part of the power tool may result in personal injury.
5. **Do not overreach. Keep proper footing and balance at all times.** This enables better control of the power tool in unexpected situations.
6. **Dress properly. Do not wear loose clothing or jewellery. Keep your hair and clothing away from moving parts.** Loose clothes, jewellery or long hair can be caught in moving parts.
7. **If devices are provided for the connection of dust extraction and collection facilities, ensure these are connected and properly used.** Use of dust collection can reduce dust-related hazards.
8. **Do not let familiarity gained from frequent use of tools allow you to become complacent and ignore tool safety principles.** A careless action can cause severe injury within a fraction of a second.
9. **Always wear protective goggles to protect your eyes from injury when using power tools. The goggles must comply with ANSI Z87.1 in the USA, EN 166 in Europe, or AS/NZS 1336 in Australia/New Zealand. In Australia/New Zealand, it is legally required to wear a face shield to protect your face, too.**

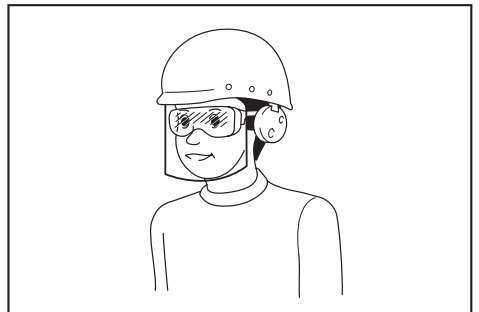

It is an employer's responsibility to enforce the use of appropriate safety protective equipments by the tool operators and by other persons in the immediate working area.

## Power tool use and care

1. **Do not force the power tool. Use the correct power tool for your application.** The correct power tool will do the job better and safer at the rate for which it was designed.
2. **Do not use the power tool if the switch does not turn it on and off.** Any power tool that cannot be controlled with the switch is dangerous and must be repaired.
3. **Disconnect the plug from the power source and/or remove the battery pack, if detachable, from the power tool before making any adjustments, changing accessories, or storing power tools.** Such preventive safety measures reduce the risk of starting the power tool accidentally.
4. **Store idle power tools out of the reach of children and do not allow persons unfamiliar with the power tool or these instructions to operate the power tool.** Power tools are dangerous in the hands of untrained users.
5. **Maintain power tools and accessories. Check for misalignment or binding of moving parts, breakage of parts and any other condition that may affect the power tool's operation. If damaged, have the power tool repaired before use.** Many accidents are caused by poorly maintained power tools.
6. **Keep cutting tools sharp and clean.** Properly maintained cutting tools with sharp cutting edges are less likely to bind and are easier to control.
7. **Use the power tool, accessories and tool bits etc. in accordance with these instructions, taking into account the working conditions and the work to be performed.** Use of the power tool for operations different from those intended could result in a hazardous situation.
8. **Keep handles and grasping surfaces dry, clean and free from oil and grease.** Slippery handles and grasping surfaces do not allow for safe handling and control of the tool in unexpected situations.
9. **When using the tool, do not wear cloth work gloves which may be entangled.** The entanglement of cloth work gloves in the moving parts may result in personal injury.

## Service

1. **Have your power tool serviced by a qualified repair person using only identical replacement parts.** This will ensure that the safety of the power tool is maintained.
2. **Follow instruction for lubricating and changing accessories.**

## Hammer drill safety warnings

### Safety instructions for all operations

1. **Wear ear protectors when impact drilling.** Exposure to noise can cause hearing loss.
2. **Use the auxiliary handle(s).** Loss of control can cause personal injury.
3. **Hold the power tool by insulated gripping surfaces, when performing an operation where the cutting accessory may contact hidden wiring or its own cord.** Cutting accessory contacting a "live" wire may make exposed metal parts of the power tool "live" and could give the operator an electric shock.
4. **Always be sure you have a firm footing. Be sure no one is below when using the tool in high locations.**
5. **Hold the tool firmly with both hands.**
6. **Keep hands away from rotating parts.**
7. **Do not leave the tool running. Operate the tool only when hand-held.**
8. **Do not touch the drill bit or the workpiece immediately after operation; they may be extremely hot and could burn your skin.**
9. **Some material contains chemicals which may be toxic. Take caution to prevent dust inhalation and skin contact. Follow material supplier safety data.**
10. **If the drill bit cannot be loosened even you open the jaws, use pliers to pull it out.** In such a case, pulling out the drill bit by hand may result in injury by its sharp edge.

### Safety instructions when using long drill bits

1. **Never operate at higher speed than the maximum speed rating of the drill bit.** At higher speeds, the bit is likely to bend if allowed to rotate freely without contacting the workpiece, resulting in personal injury.
2. **Always start drilling at low speed and with the bit tip in contact with the workpiece.** At higher speeds, the bit is likely to bend if allowed to rotate freely without contacting the workpiece, resulting in personal injury.
3. **Apply pressure only in direct line with the bit and do not apply excessive pressure.** Bits can bend causing breakage or loss of control, resulting in personal injury.

## SAVE THESE INSTRUCTIONS.

**⚠WARNING:** DO NOT let comfort or familiarity with product (gained from repeated use) replace strict adherence to safety rules for the subject product. MISUSE or failure to follow the safety rules stated in this instruction manual may cause serious personal injury.

# FUNCTIONAL DESCRIPTION

## ⚠ CAUTION:

- Always be sure that the tool is switched off and unplugged before adjusting or checking function on the tool.

## Switch action

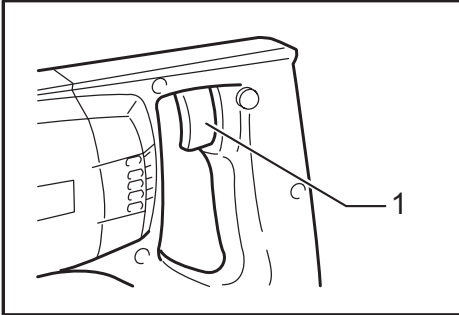

► 1. Switch trigger

## ⚠ CAUTION:



- Before plugging in the tool, always check to see that the switch trigger actuates properly and returns to the "OFF" position when released.

To start the tool, simply pull the switch trigger. Tool speed is increased by increasing pressure on the switch trigger. Release the switch trigger to stop.

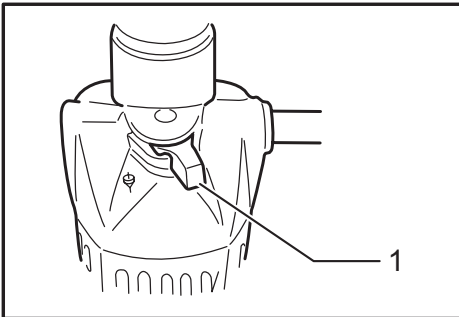
## Selecting the action mode



► 1. Change lever

This tool has an action mode changing lever. For rotation with hammering, turn the lever to the position of  symbol. For rotation only, turn the lever to the position of  symbol.

## Torque limiter

### ⚠ CAUTION:

- Do not continue to operate the tool for more than two seconds while the clutch is slipping.
- Do not let the torque limiter actuate too frequently.

This tool is equipped with a clutch-type torque limiter. The clutch will slip when a certain torque level is reached, causing the motor to disengage from the output shaft. When this happens, the chuck will stop turning.

## ASSEMBLY

### ⚠ CAUTION:

- Always be sure that the tool is switched off and unplugged before carrying out any work on the tool.

## Installing side grip (auxiliary handle)

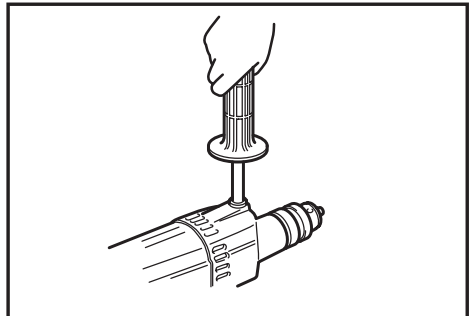

Always use the side grip to ensure operating safety. Screw the side grip on the tool securely. The side grip can be installed on either side of the tool, whichever is convenient.

## Installing or removing diamond core bit or drill bit

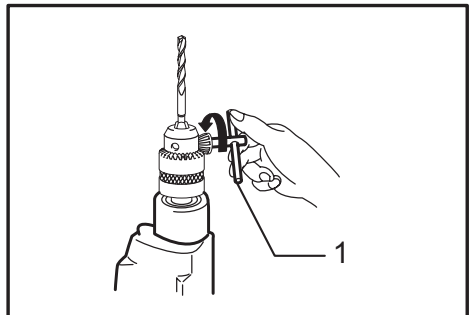

► 1. Chuck key

To install the bit, place it in the chuck as far as it will go. Tighten the chuck by hand. Place the chuck key in each of the three holes and tighten clockwise. Be sure to tighten all three chuck holes evenly. To remove the bit, turn the chuck key counterclockwise in just one hole, then loosen the chuck by hand. After using the chuck key, be sure to return to the original position.

**NOTE:**

- A pilot hole is not required for 22 mm and 28 mm diameter core bits.

**Hammer drilling operation  
(with a tungsten-carbide tipped bit)**

**CAUTION:**

- There is a tremendous and sudden twisting force exerted on the tool/bit at the time of hole break-through, when the hole becomes clogged with chips and particles, or when striking reinforcing rods embedded in the concrete. Always use the side grip (auxiliary handle) and firmly hold the tool by both side grip and switch handle during operations. Failure to do so may result in the loss of control of the tool and potentially severe injury.

When drilling in concrete, granite, tile, etc., move the action mode changing lever to the position of  to use "rotation with hammering" action.

**OPERATION**

**CAUTION:** Always use the side grip (auxiliary handle) and firmly hold the tool by both side grip and switch handle during operations.

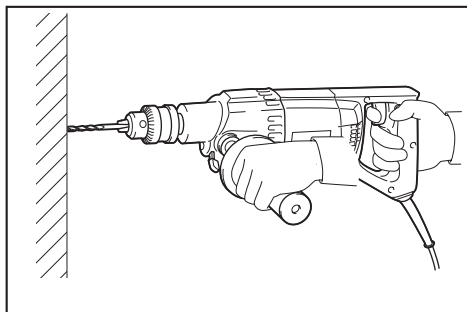

**Blow-out bulb (optional accessory)**

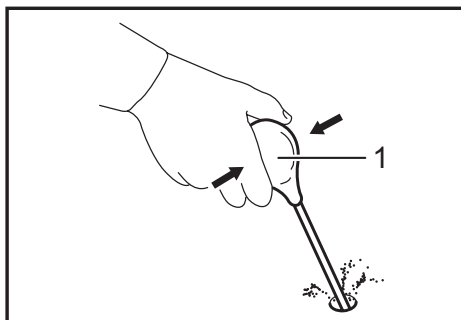

▶ 1. Blow-out bulb

After drilling the hole, use the blow-out bulb to clean the dust out of the hole.

**Diamond core drilling operation**

**CAUTION:**

- Never use "rotation with hammering" action when drilling with a diamond core drill. The core bit may be damaged.

When diamond core drilling, adopt the following procedure:

1. Prior to using a diamond core bit, drill a 13 mm pilot hole using a masonry drill bit (tungsten-carbide tipped hammer bit).
2. Remove the masonry drill bit from the drill chuck.
3. Set the change lever from "rotation with hammering" position to "rotation only" position.
4. Install a diamond core bit into the chuck.
5. Place the diamond core bit on drilling location so that the center bit is inserted into the pilot hole.
6. When drilling, always hold the tool squarely against material.
7. Do not force the core bit, allow the core bit to do the work. This will prolong the life of the core bit and reduce breakage.
8. Ensure that the masonry dust/swarf produced during drilling is regularly removed. Allowing the dust/swarf to accumulate will result in overheating and excessive clutch/torque limiter wear and the loss of segments from the core bit.
9. When entering or leaving a hole, ensure that the core bit is rotating.
10. If the core bit starts to vibrate and when the core bit begins to break through material, reduce pressure immediately.
11. After use, store the core bit carefully in its box and remember that it is a diamond core bit.

**Drilling operation  
(with a conventional drill bit)**

When drilling in wood, metal or plastic materials, move the action mode changing lever to the position of  to use "rotation only" action.

**Drilling in wood**

When drilling in wood, the best results are obtained with wood drills equipped with a guide screw. The guide screw makes drilling easier by pulling the bit into the workpiece.

**Drilling in metal**

To prevent the bit from slipping when starting a hole, make an indentation with a center-punch and hammer at the point to be drilled. Place the point of the bit in the indentation and start drilling.

Use a cutting lubricant when drilling metals. The exceptions are iron and brass which should be drilled dry.

### **⚠ CAUTION:**

- Pressing excessively on the tool will not speed up the drilling. In fact, this excessive pressure will only serve to damage the tip of your bit, decrease the tool performance and shorten the service life of the tool.
- There is a tremendous force exerted on the tool/bit at the time of hole break through. Hold the tool firmly and exert care when the bit begins to break through the workpiece.
- Always secure small workpieces in a vise or similar hold-down device.

## **MAINTENANCE**

### **⚠ CAUTION:**

- Always be sure that the tool is switched off and unplugged before attempting to perform inspection or maintenance.
- Never use gasoline, benzine, thinner, alcohol or the like. Discoloration, deformation or cracks may result.

To maintain product SAFETY and RELIABILITY, repairs, carbon brush inspection and replacement, any other maintenance or adjustment should be performed by Makita Authorized Service Centers, always using Makita replacement parts.

## **OPTIONAL ACCESSORIES**

### **⚠ CAUTION:**

- These accessories or attachments are recommended for use with your Makita tool specified in this manual. The use of any other accessories or attachments might present a risk of injury to persons. Only use accessory or attachment for its stated purpose.

If you need any assistance for more details regarding these accessories, ask your local Makita Service Center.

- Tungsten-carbide tipped drill bit
- Hole saw
- Diamond core bit (Dry type)
- Center bit
- Center bit shank
- Diamond core bit (wet type)
- Guide ring
- Sheet
- Sponge
- Water protection collar
- Blow-out bulb
- Chuck key
- Side grip
- Plastic carrying case

**NOTE:** Some items in the list may be included in the tool package as standard accessories. They may differ from country to country.

**Makita Europe N.V.** Jan-Baptist Vinkstraat 2,  
3070 Kortenberg, Belgium

**Makita Corporation** 3-11-8, Sumiyoshi-cho,  
Anjo, Aichi 446-8502 Japan

[www.makita.com](http://www.makita.com)

883731H991 EN 20201218
------------------------------