

Leica Lino L4P1



- when it has to be **right**

Leica
Geosystems

Overview	2
Technical data	3
Instrument Set-up	4
Operations	7
Message Codes	9
Accuracy Check	10
Care	13
Warranty	14
Safety instructions	15

Overview

The Leica Lino L4P1 is a laser levelling instrument operating with a class 2 laser. See chapter Technical data for scope of use.

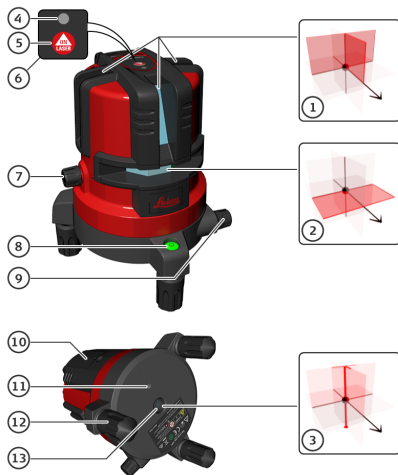

1 Window of vertical lines

2 Window of horizontal line

3 Window of plumbing

4 Status LED (on keypad)

5 Laser key (on keypad)

6 Keypad

7 Levelling lock

8 Spirit level

9 Fine adjustment for vertical lines

10 Battery pack

11 Tripod thread 1/4"

12 Adjustable foot

13 Tripod thread 5/8"

Technical data

Range (depending on lighting conditions)	15 m
Range with laser receiver	80 m
Accuracy	2 mm at 10 m
Self-levelling range	+/- 3°
Number of laser lines	4
Number of laser dots	1
Beam direction	Vertical, horizontal, up, down (see Laser classification)
Battery types	Rechargeable Li-Ion batteries or Alkaline batteries 4 x AA, 1.5V
Battery life Li-Ion batteries	24 h
Protection level	IP 54 (dust-and splash water protected)
Tripod thread	1/4", 5/8"
Operating temperature	10°C - 50°C
Storage temperature	-25°C - 70°C
Dimension (H x D x W)	125 x 125 x 162 mm
Weight (with Li-Ion batteries)	1173 g

Introduction

The safety instructions (see Safety Instructions) and the user manual should be read through carefully before the product is used for the first time.

The person responsible for the product must ensure that all users understand these directions and adhere to them.

The symbols used have the following meanings:

WARNING

Indicates a potentially hazardous situation or an unintended use which, if not avoided, will result in death or serious injury.

CAUTION

Indicates a potentially hazardous situation or an unintended use which, if not avoided, may result in minor injury and/or appreciable material, financial and environmental damage.

 Important paragraphs which must be adhered to in practice as they enable the product to be used in a technically correct and efficient manner.

Levelling lock

See also Levelling the instrument

Levelling unlocked

 In the unlocked position the instrument automatically levels itself within the specified inclination range. (See Technical data)

Levelling locked

Turn the levelling lock in order to transport or tilt the instrument beyond the self-levelling range. When locked, the pendulum is fixed and the self-levelling function is deactivated. In this case the laser blinks every 3sec.



Laser receiver

To be able to detect the laser lines over long distances (>15 m) or in unfavourable lighting conditions, a laser receiver can be used.

 We recommend the Leica RVL80 laser receiver.

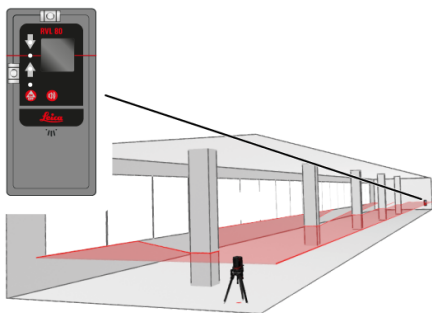

Li-Ion battery

Charge Li-Ion battery

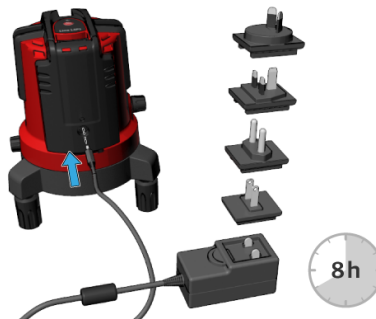

Charge the Li-Ion battery before using it for the first time. While charging, the instrument may heat up. This is normal and should not affect the instrument's lifespan or performance. At the recommended storage temperature of -20°C to $+30^{\circ}\text{C}$ (-4°F to $+86^{\circ}\text{F}$), batteries containing a 50% to 100% charge can be stored up to 1 year. After this storage period the batteries must be recharged.

CAUTION

Connecting the charger using the wrong adapter may cause serious damage to the instrument. Any damage caused by misuse is not covered by warranty. Use only Leica-approved chargers, batteries and cables. Unapproved chargers or cables can cause the battery to explode or damage the instrument.

Insert Li-Ion battery



Insert the battery-pack by pressing it down and then tilting it towards the housing as shown until it snaps in.

Instrument Set-up

Alkaline batteries

To ensure a reliable use, we recommend using high quality Alkaline batteries.

Insert Alkaline batteries

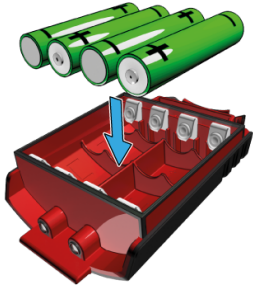

Insert Alkaline batteries in the battery-pack.

Insert the battery-pack

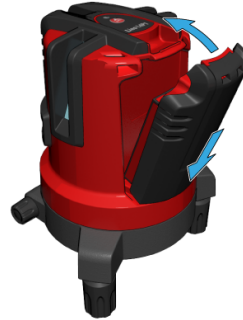

Insert the battery-pack by pressing it down and then tilting it towards the housing as shown until it snaps in.

Switching ON/OFF

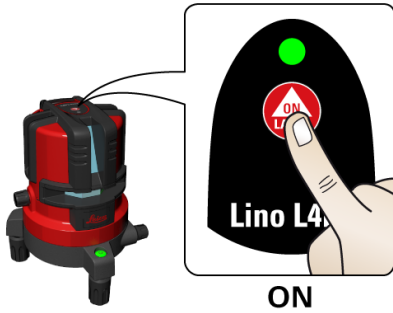

Functions

Check if self-levelling is required and correspondingly activated.. (See Levelling lock for details)

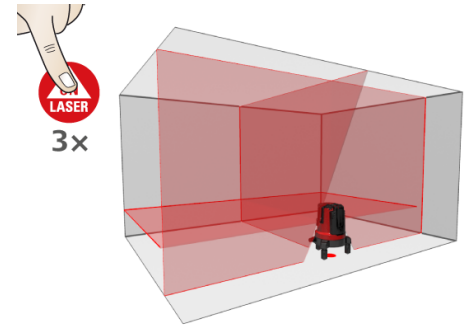
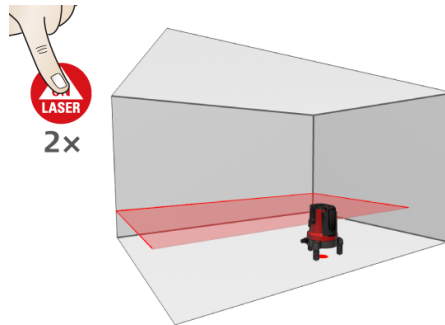
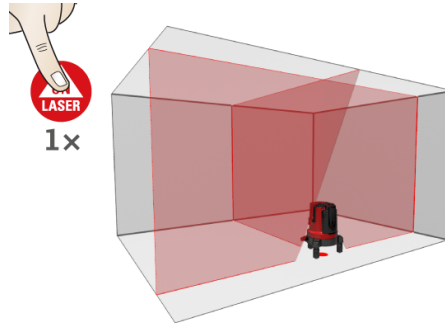

Alignment of vertical laser lines

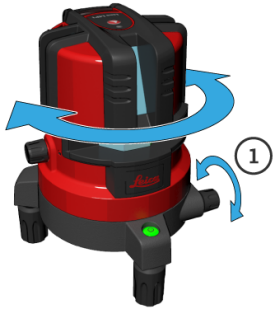

Turn adjustment knob (1) for fine adjustment of vertical laser lines.

Message Codes

Laser	LED	Cause	Correction
ON	lights red	instrument has low power	Charge Li-Ion battery or change Alkaline batteries
OFF	blinks red	Temperature alert	Cool down or heat up instrument
blinks	blinks red	instrument is out of self-levelling range	Place the instrument almost horizontal and self-levelling will start automatically
blinks every 3 sec	lights green	Levelling lock is activated for working without self-levelling	

i Check the accuracy of your Leica Lino L4P1 regularly and particularly before important measuring tasks. Check Levelling lock before checking the accuracy.

Levelling

Checking the accuracy of the levelling

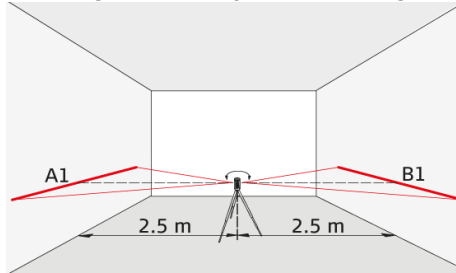

Set the instrument on a tripod half-way between two walls (A+B) that are approx. 5 m apart. Place the lock switch in the "Unlocked" position. Direct the instrument at wall A and switch on the instrument. Activate the horizontal laser line or laser point and mark the position of the line or the point on wall (A1). Rotate the instrument by 180° and mark the horizontal laser line or the laser point in exactly the same way on wall (B1).

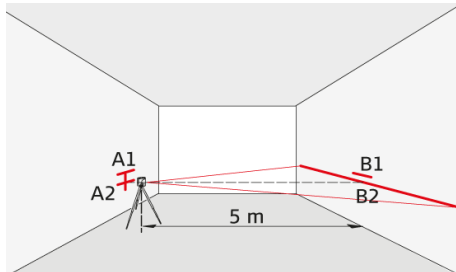

Then place the instrument at the same elevation as close as possible to wall A and again mark the horizontal laser line or the laser point on wall A (A2). Rotate the instrument by 180° again and mark the laser on wall B (B2). Measure the distances of the marked points A1-A2 and B1-B2. Calculate the difference of the two measurements.

$$|(A1 - A2) - (B1 - B2)| \leq 2 \text{ mm}$$

If the difference does not exceed 2 mm, then the Leica Lino L4P1 is within tolerance.

Vertical and horizontal line

Checking the accuracy of the horizontal line

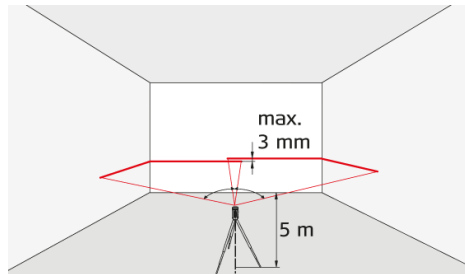

Place the lock switch in the "Unlocked" position. Position the instrument approx. 5 m away from the wall. Direct the instrument at the wall and switch on. Activate the laser line and mark the intersection point of laser crosshairs on the wall. Swivel the instrument to the right and then to the left. Observe the vertical deviation of the horizontal line from the marking. If the difference does not exceed 3 mm, then the Leica Lino L4P1 is within tolerance.

Checking the accuracy of the vertical line

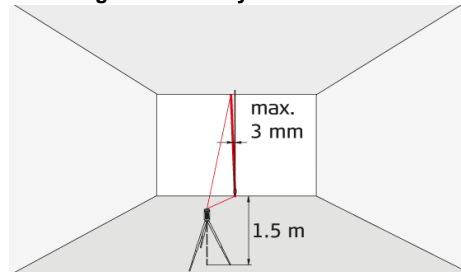

Place the lock switch in the "Unlocked" position. As a reference, use a plumb-bob and attach it as close as possible to an approx. 3 m high wall. Position the instrument at a distance of approx. 1.5 m from the wall at an elevation of approx. 1.5 m. Direct the instrument at the wall and switch on. Rotate the instrument and align it with the bottom of the plumb line. Now read off the maximum deviation of the laser line from the top of the plumb line. If the difference does not exceed 3 mm, then the Leica Lino L4P1 is within tolerance.

Vertical plumb points

Checking the accuracy of the upper plumb point:

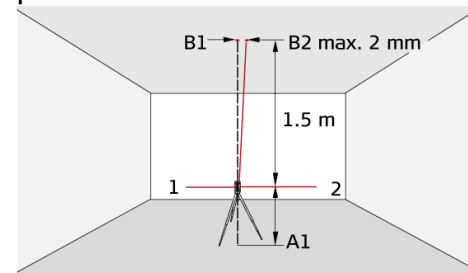

Set up the laser on its tripod or wall mount bracket near point A1 at a minimum distance of 1.5 m from point B1. The horizontal laser is aligned in direction 1. Mark the laser points A1 and B1 with a pin.

Checking the accuracy of the lower plumb point:

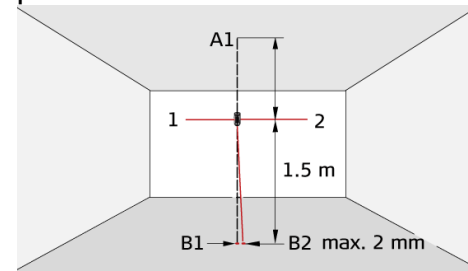

Accuracy Check

Rotate the instrument by 180° so that it points in the opposite direction 2 to direction 1. Adjust the instrument so that the laser beam hits point A1 exactly. If point B2 is no further than 2 mm away from point B1, then the Leica Lino L4P1 is within tolerance.

Never immerse the device in water. Wipe off dirt with a damp soft cloth. Never use aggressive cleaning agents or solvents. Treat the instrument with the same care that you would apply to binoculars or a camera. Dropping or violent shaking of the instrument may damage it. Check the instrument for any damage before using it. Check the levelling accuracy of the instrument regularly.

Warranty under PROTECT by Leica Geosystems

Lifetime Manufacturer's Warranty

Warranty coverage for the entire usage time of the product under PROTECT according to Leica Geosystems International Limited Warranty and PROTECT General Terms & Conditions set out under www.leica-geosystems.com. Free of charge repair or replacement of all products or any parts under PROTECT that suffer defects as a result of faults in materials or workmanship.

3 Years No Cost

Additional services should the product under PROTECT become defective and require servicing under normal conditions of use, as described in the user manual, at no additional charge.

To receive the "3 Years No Cost" period, the product under PROTECT must be registered at myworld.leica-geosystems.com within 8 weeks of the purchase date. If the product under PROTECT is not registered, a "2 years No Cost" period applies.



The person responsible for the instrument must ensure that all users understand these directions and adhere to them.

Areas of responsibility

Responsibilities of the manufacturer of the original equipment:

Leica Geosystems AG
Heinrich-Wild-Strasse
CH-9435 Heerbrugg
Internet: www.leica-geosystems.com

The company above is responsible for supplying the product, including the User Manual in a completely safe condition.

The company above is not responsible for third party accessories.

Responsibilities of the person in charge of the instrument:

- To understand the safety instructions on the product and the instructions in the User Manual.
- To be familiar with local safety regulations relating to accident prevention.
- Always prevent access to the product by unauthorised personnel.

Permitted use

- Projection of horizontal and vertical laser lines and laser points

Prohibited use

- Using the product without instruction
- Using outside the stated limits
- Deactivation of safety systems and removal of explanatory and hazard labels
- Opening of the equipment by using tools (screwdrivers, etc.)
- Carrying out modification or conversion of the product
- Deliberate dazzling of third parties; also in the dark
- Inadequate safeguards at the surveying site (e.g. when measuring on roads, construction sites, etc.)

Hazards in use

WARNING

Watch out for erroneous measurements if the instrument is defective or if it has been dropped or has been misused or modified. Carry out periodic test measurements. Particularly after the instrument has been subject to abnormal use, and before, during and after important measurements.

CAUTION

Never attempt to repair the product yourself. In case of damage, contact a local dealer.

WARNING

Changes or modifications not expressly approved could void the user's authority to operate the equipment.

Limits of use

-  Refer to section Technical data. The instrument is designed for use in areas permanently habitable for humans. Do not use the product in explosion hazardous areas or in aggressive environments.

Disposal

CAUTION

Flat batteries must not be disposed of with household waste. Care for the environment and take them to the collection points provided in accordance with national or local regulations.

The product must not be disposed with household waste. Dispose of the product appropriately in accordance with the national regulations in force in your country. Adhere to the national and country specific regulations.

Product specific treatment and waste management can be downloaded from our homepage.

Transport

Transport of instrument

To safely transport the instrument, set the lock switch to "Locked"

Transport of Li-Ion battery

WARNING

During transport, shipping or disposal of batteries it is possible for inappropriate mechanical influences to constitute a fire hazard.

Precautions:

Before shipping the product or disposing it, discharge the batteries by running the product until they are flat. When transporting or shipping batteries, the person in charge of the product must ensure that the applicable national and international rules are observed. Before transportation or shipping, contact your local passenger or freight transport company.

WARNING

High mechanical stress, high ambient temperatures or immersion into fluids can cause leakage, fire or explosion of the batteries.

Precautions:

Protect the batteries from mechanical influences and high ambient temperatures. Do not drop or immerse batteries into fluids.

 For further information about charging please refer to Li-Ion battery.

Electromagnetic Compatibility (EMC)

WARNING

The device conforms to the most stringent requirements of the relevant standards and regulations. However, the possibility of causing interference in other devices cannot be totally excluded.

Laser classification

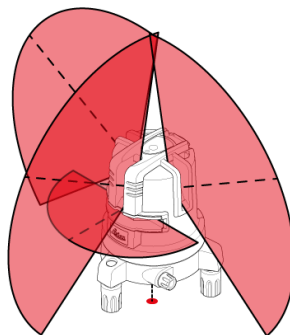

The instrument produces visible laser beams, which are emitted from the instrument. It is a Class 2 laser product in accordance with:

- IEC60825-1 : 2014 „Radiation safety of laser products“

Laser Class 2 products:

Do not stare into the laser beam or direct it towards other people unnecessarily. Eye protection is normally afforded by aversion responses including the blink reflex.

WARNING

Looking directly into the beam with optical aids (e.g. binoculars, telescopes) can be hazardous.

CAUTION

Looking into the laser beam may be hazardous to the eyes.

Wavelength
620 - 690 nm

Maximum radiant output power for classification
<1 mW

Pulse duration
35 - 65 μ s, cw

Pulse repetition frequency
10 kHz

Beam divergence line
< 200°

Beam divergence point
< 1.5 mrad

Labelling



Subject to change (drawings, descriptions and technical data) without prior notice.